

SIEMENS

SIMODRIVE 611, SIMOVERT MASTERDRIVES

General Section for Synchronous Motors

Configuration Manual

Foreword

Electrical Data

1

Mechanical Data

2

Configuration

3

Electrical Connections

4

Motor Components

5

Appendix

A

Safety Guidelines

This manual contains notices you have to observe in order to ensure your personal safety, as well as to prevent damage to property. The notices referring to your personal safety are highlighted in the manual by a safety alert symbol, notices referring only to property damage have no safety alert symbol. These notices shown below are graded according to the degree of danger.



Danger

indicates that death or severe personal injury **will** result if proper precautions are not taken.



Warning

indicates that death or severe personal injury **may** result if proper precautions are not taken.



Caution

with a safety alert symbol, indicates that minor personal injury can result if proper precautions are not taken.

Caution

without a safety alert symbol, indicates that property damage can result if proper precautions are not taken.

Notice

indicates that an unintended result or situation can occur if the corresponding information is not taken into account.

If more than one degree of danger is present, the warning notice representing the highest degree of danger will be used. A notice warning of injury to persons with a safety alert symbol may also include a warning relating to property damage.

Qualified Personnel

The device/system may only be set up and used in conjunction with this documentation. Commissioning and operation of a device/system may only be performed by **qualified personnel**. Within the context of the safety notes in this documentation qualified persons are defined as persons who are authorized to commission, ground and label devices, systems and circuits in accordance with established safety practices and standards.

Prescribed Usage

Note the following:



Warning

This device may only be used for the applications described in the catalog or the technical description and only in connection with devices or components from other manufacturers which have been approved or recommended by Siemens. Correct, reliable operation of the product requires proper transport, storage, positioning and assembly as well as careful operation and maintenance.

Trademarks

All names identified by ® are registered trademarks of the Siemens AG. The remaining trademarks in this publication may be trademarks whose use by third parties for their own purposes could violate the rights of the owner.

Disclaimer of Liability

We have reviewed the contents of this publication to ensure consistency with the hardware and software described. Since variance cannot be precluded entirely, we cannot guarantee full consistency. However, the information in this publication is reviewed regularly and any necessary corrections are included in subsequent editions.

Foreword

Information on the documentation

Information on the documentation

This document is part of the Technical Customer Documentation which has been developed for SIMODRIVE and SIMOVERT MASTERDRIVES drive converter systems. All of the documents are available individually. The documentation list, which includes all Advertising Brochures, Catalogs, Overviews, Short Descriptions, Operating Instructions and Technical Descriptions with Order No., ordering address and price can be obtained from your local Siemens office.

This document does not purport to cover all details or variations in equipment, nor to provide for every possible contingency to be met in connection with installation, operation or maintenance.

We would also like to point-out that the contents of this document are neither part of nor modify any prior or existing agreement, commitment or contractual relationship. The sales contract contains the entire obligations of Siemens. The warranty contained in the contract between the parties is the sole warranty of Siemens. Any statements contained herein neither create new warranties nor modify the existing warranty.

Structure of the documentation

Table 1 Configuration Manuals, individual sections

Title	Order number	Language
Synchronous Motors, General Section for SIMODRIVE and SIMOVERT MASTERDRIVES MC	6SN1197-0AD07-0AP□	German
Synchronous Motors, 1FK7 Motor Section for SINAMICS S120 incl. General Section	6SN1197-0AD16-0AP□	German
Synchronous Motors, 1FT6 Motor Section for SINAMICS S120 incl. General Section	6SN1197-0AD12-0AP□	German
Synchronous Motors, 1FK7 Motor Section for SIMODRIVE and SIMOVERT MASTERDRIVES MC	6SN1197-0AD06-0AP□	German
Synchronous Motors, 1FK6 Motor Section for SIMODRIVE and SIMOVERT MASTERDRIVES MC	6SN1197-0AD05-0AP□	German
Synchronous Motors, 1FT6 Motor Section for SIMODRIVE and SIMOVERT MASTERDRIVES MC	6SN1197-0AD02-0AP□	German
Synchronous Motors, 1FT5 Motor Section for SIMODRIVE	6SN1197-0AD01-0AP□	German

Target group of the Configuration Manual

The Configuration Manual addresses planners and design engineers. It supports you when selecting motors, calculating the drive components, selecting the required accessories as well as when selecting line and motor-side power options.

Technical Support

If you have any questions, please contact the following Hotline:

Phone: +49 (0) 180 5050–222
Fax: +49 (0) 180 5050–223
Internet: <http://www.siemens.com/automation/support-request>

Please send any questions about the documentation (e.g. suggestions for improvement, corrections) to the following fax number or email address:

Fax: +49 (0) 9131 98–63315
Fax form: Refer to the correction sheet at the end of the document
E-mail: <mailto:motioncontrol.docu@siemens.com>

Information on the products

Up-to-date information about our products can be found on the Internet at the following address:

<http://www.siemens.com/motioncontrol>

Safety Guidelines



Danger

Start-up/commissioning is absolutely prohibited until it has been completely ensured that the machine, in which the components described here are to be installed, is in full compliance with the specifications of Directive 98/37/EC.

Only appropriately qualified personnel may commission SIMODRIVE and SIMOVERT MASTERDRIVES drive units and the synchronous motors.

This personnel must carefully refer to the technical customer documentation belonging to the product and be knowledgeable and observe the specified information and instructions on the hazard and warning labels.

Operational electrical equipment and motors have parts and components which are at hazardous voltage levels.

When the machine or system is operated, hazardous axis movements can occur.

All of the work carried-out on the electrical machine or system must be carried-out with it in a no-voltage condition.

SIMODRIVE and SIMOVERT MASTERDRIVES drive units have been designed for operation on low-ohmic grounded line supplies (TN line supplies).



Warning

The successful and safe operation of this equipment and motors is dependent on professional transport, storage, installation and mounting as well as careful operator control, service and maintenance.

For special versions of the drive units and motors, information and data in the catalogs and quotations additionally apply.

In addition to the danger and warning information/instructions in the technical customer documentation supplied, the applicable domestic, local and plant-specific regulations and requirements must be carefully taken into account.



Caution

The motors can have surface temperatures of over +100° C.

This is the reason that temperature-sensitive components, e.g. cables or electronic components may neither be in contact nor be attached to the motor.

When handling cables, please observe the following:

- are not damaged
 - are not subject to tensile stress and
 - are not touched by rotating components.
-

Caution

SIMODRIVE and SIMOVERT MASTERDRIVES drive units with synchronous motors are subject, as part of the type test, to a voltage test corresponding to EN 50178. According to EN 60204-1, Section 19.4, while electrical equipment of industrial machines are being subject to a voltage test, all of the SIMODRIVE and SIMOVERT MASTERDRIVES drive unit connections must be disconnected/withdrawn in order to avoid damaging the SIMODRIVE and SIMOVERT MASTERDRIVES drive units.

Motors should be connected-up according to the circuit diagram provided. They must not be connected directly to the three-phase supply because this will damage them.

Note

SIMODRIVE and SIMOVERT MASTERDRIVES drive units with synchronous motors fulfill, when operational and in dry equipment rooms, the Low-Voltage Directive 73/23/EEC.

SIMODRIVE and SIMOVERT MASTERDRIVES drive units with synchronous motors fulfill, in the configurations specified in the associated EC Declaration of Conformity, EMC Directive 89/336/EEC.

ESDS instructions



Caution

ElectroStatic Discharge Sensitive Devices (ESDS) are individual components, integrated circuits, or modules that can be damaged by electrostatic fields or discharges.

ESDS regulations for handling boards and equipment:

When handling components that can be destroyed by electrostatic discharge, it must be ensured that personnel, the workstation and packaging are well grounded!

Personnel in ESDS zones with conductive floors may only touch electronic components if they are

- grounded through an ESDS bracelet and
- wearing ESDS shoes or ESDS shoe grounding strips.

Electronic boards may only be touched when absolutely necessary.

Electronic boards may not be brought into contact with plastics and articles of clothing manufactured from man-made fibers.

Electronic boards may only be placed on conductive surfaces (table with ESDS surface, conductive ESDS foam rubber, ESDS packing bag, ESDS transport containers).

Electronic boards may not be brought close to data terminals, monitors or television sets. Minimum clearance to screens > 10 cm).

Measurements may only be carried-out on electronic boards and modules if

- the measuring instrument is grounded (e.g. via a protective conductor) or
 - before making measurements with a potential-free measuring device, the measuring head is briefly discharged (e.g. by touching an unpainted blank piece of metal on the control cabinet).
-

Functional requirements

The appropriate standards, regulations are directly assigned to the functional requirements.

Table of contents

	Foreword	iii
1	Electrical Data	1-1
1.1	Definitions	1-1
2	Mechanical Data.....	2-1
2.1	Definitions	2-1
2.2	Selecting the motor degree of protection.....	2-5
2.3	Cooling	2-7
3	Configuration	3-1
3.1	Engineering software	3-1
3.1.1	NCS D Configurator	3-1
3.1.2	PATH Plus engineering tool.....	3-2
3.2	Procedure when engineering.....	3-4
3.3	Dimensioning	3-5
3.3.1	1. Clarification of the type of drive	3-5
3.3.2	2. Definition of supplementary conditions and integration into an automation system.....	3-5
3.3.3	3. Definition of the load, calculation of max. load torque, definition of the motor	3-6
4	Electrical Connections.....	4-1
4.1	Power cable	4-1
4.2	Order Nos. for power cables.....	4-3
4.2.1	Overview	4-3
4.2.2	Prefabricated power cable without brake conductors	4-5
4.2.3	Prefabricated power cable with brake conductors	4-6
4.2.4	Power cable sold by the meter without brake conductors	4-6
4.2.5	Power cable sold by the meter with brake conductors	4-7
4.2.6	Signal cable.....	4-7
4.2.7	Shielding	4-8
5	Motor Components.....	5-1
5.1	Influence of the mounting type and mounted components.....	5-1
5.2	Drive-out couplings	5-2
5.3	Armature short-circuit braking.....	5-4
5.4	Holding brake	5-7
5.5	Thermal motor protection.....	5-11
A	Appendix.....	A-1
A.1	References.....	A-1
	Index.....	Index-1

Electrical Data

1.1 Definitions

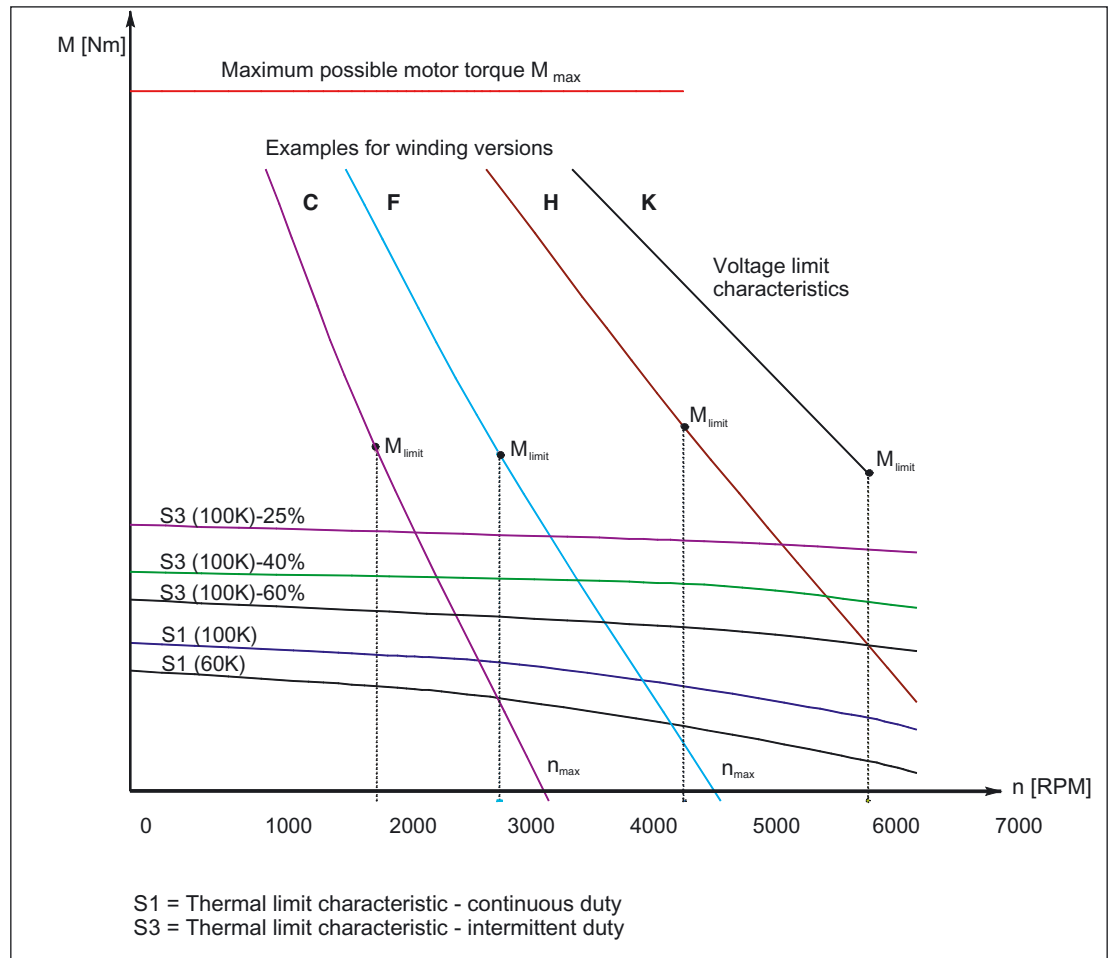

Figure 1-1 Speed-torque diagram, examples for various winding versions

100 K, 60 K values

100 K or 60 K is the average winding temperature rise in Kelvin.

105 K corresponds to a utilization according to temperature Class F.

60 K lies in the utilization within temperature Class B. The 60 K utilization is used:

- if the temperature of the enclosure/housing must lie below 90 °C for safety reasons
- or the shaft temperature rise would have a negative impact on the mounted machine

Generally, for all data, a permissible ambient temperature of 40 °C applies for naturally-ventilated and force-ventilated motors; for water-cooled motors, a cooling-medium temperature of 35 °C.

Torque characteristics

Several armature circuit versions (different rated speeds n_N) are possible within a frame size. A high overload capability is provided over the complete speed control range.

The following limits always apply for all synchronous motor - drive converter module combinations.

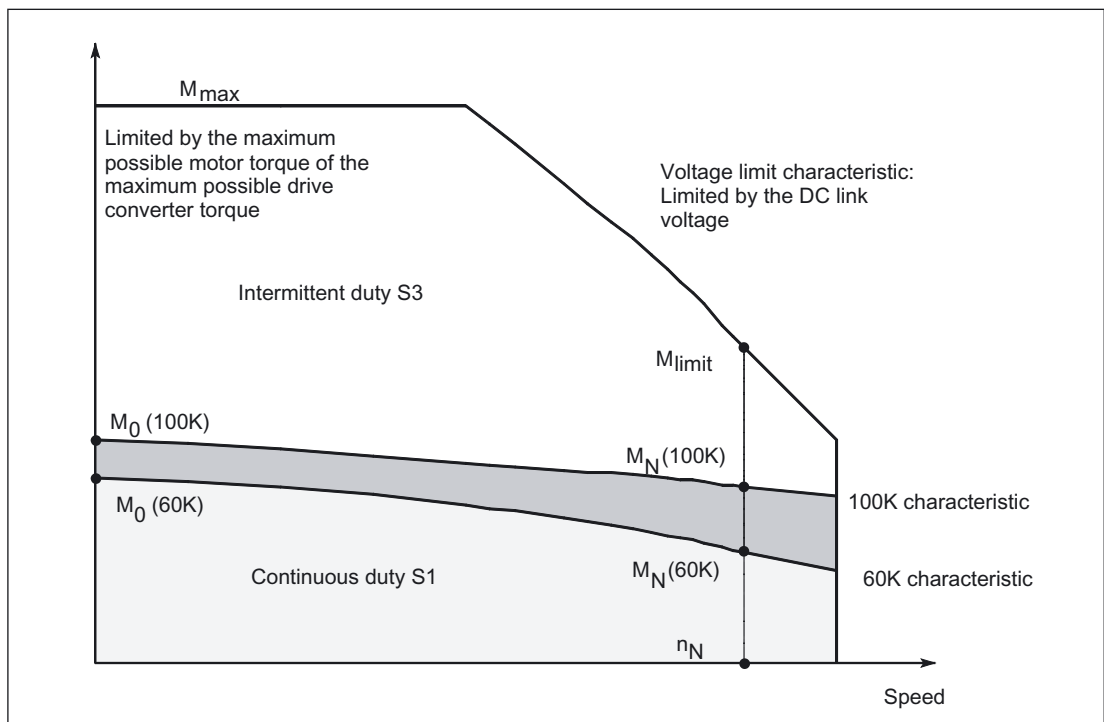

Figure 1-2 Torque characteristics of synchronous motors

Thermal limiting characteristic

In the diagram this corresponds to the S1 (100 K) characteristic. Also in intermittent duty, the geometrical average must not exceed this value.

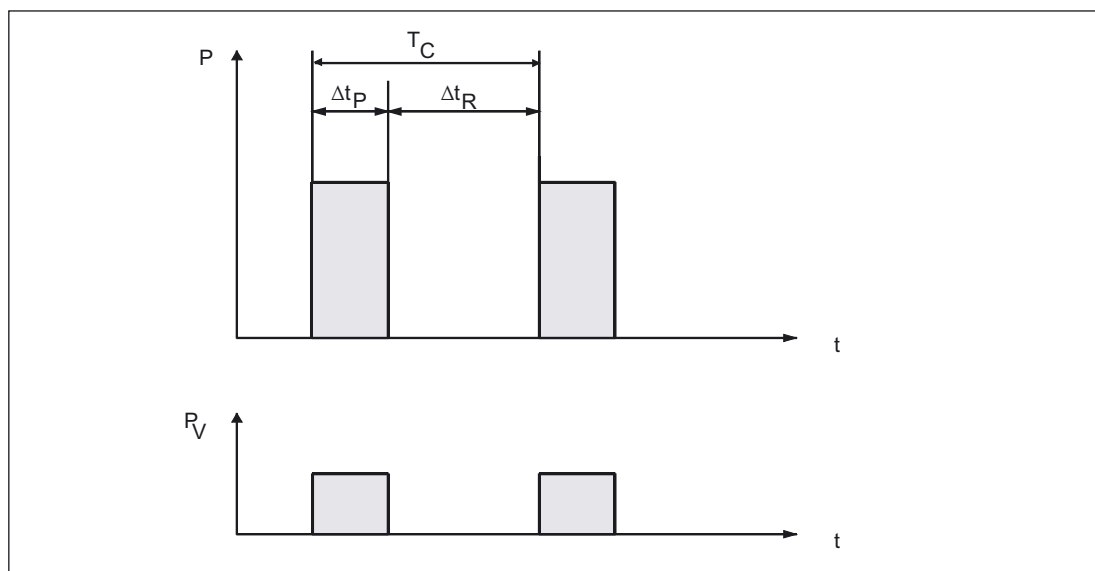

Figure 1-3 Periodic intermittent duty - duty type S3

- P = Load
 - P_V = Electrical losses
 - t = Time
 - T_C = Duty duration 10 min (if not otherwise specified)
 - Δt_P = Operating time with constant load
 - Δt_R = Standstill time with windings in the no-current state
- Relative power-on duration = $\Delta t_P / T_C = 25\%, 40\%, 60\%$

Voltage limiting characteristics

The motor EMF increases proportionally with the speed. Only the difference between the DC link voltage and the increasing motor counter-voltage can be used to impress the current. This limits the magnitude of the current which can be impressed at high speeds.



Warning

Continuous duty to the right of the voltage limiting characteristic and in the range above the S1 characteristic is thermally inadmissible for the motor (refer to Fig. "Torque characteristics of synchronous motors").

The voltage limiting characteristic of a motor with 6000 RPM rated speed lies far above that of the same motor type with 2000 RPM. However, for the same torque, this motor requires a significantly higher current. This means that it is practical to select the rated speed that this does not lie too far above the maximum speed required for the application. The size (rating) of the drive converter module (current requirement) can be minimized in this fashion.

Table 1-1 Code letter, winding version

Rated speed n_N [RPM]	Winding version (10th position of the Order No.)
1200	A
1500	B
2000	C
2500	D
3000	F
4000	G
4500	H
6000	K

Offset of the voltage limiting characteristic

Notice

The offset of the voltage limiting characteristic only applies for linear limiting characteristics, e.g. for 1FK6 and 1FK7 motors.

In order to identify the limits of the motor for a drive converter output voltage (V_{mot}) not equal to 340 V, 380 V or 425 V, the associated voltage limiting characteristic shown must be shifted (offset) for the particular new output voltage ($V_{\text{mot, new}}$).

The degree of offset is obtained as follows:

For an output voltage of $V_{\text{mot, new}}$, an offset is obtained along the X axis (speed) by a factor of:

$$\frac{V_{\text{mot, new}}}{V_{\text{mot}}}$$

$V_{\text{mot, new}}$ = new drive converter output voltage
 V_{mot} = drive converter output voltage from the characteristic for 340 V, 380 V or 425 V

Notice

It is only possible to shift the voltage limiting characteristic, if the condition

$V_{\text{mot, new}} > V_{\text{iN}}$ is fulfilled.

The induced voltage V_{iN} is specified on the motor rating plate.

$$V_{\text{iN}} = k_E \cdot n_N / 1000$$

Calculating the new limiting torque with the new limiting characteristic

$$M_{\text{limit, new}} = \frac{V_{\text{mot, new}} - V_{iN}}{V_{\text{mot}} - V_{iN}} \cdot M_{\text{limit}}$$

The value M_{limit} is read-off from the limiting characteristic for V_{mot} (value at the rated speed).

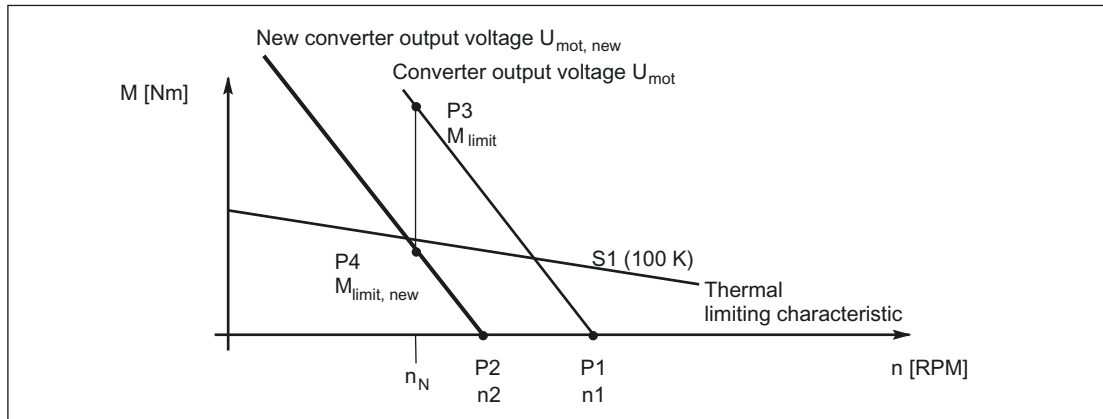

Figure 1-4 The voltage limiting characteristic is shifted from V_{mot} to $V_{\text{mot, new}}$

- P1 The voltage limiting characteristic, specified for V_{mot} intersects with the x axis (speed) at n_1 [RPM].
- P2 The point where the voltage limiting characteristic intersects with the x axis is shifted from n_1 to n_2 .

$$n_2 \text{ [RPM]} = n_1 \cdot \frac{V_{\text{mot, new}}}{V_{\text{mot}}}$$

- P3 Read-off M_{limit} at the voltage limiting characteristic specified for V_{mot} .

Calculating $M_{\text{limit, new}}$:

$$M_{\text{limit, new}} = \frac{V_{\text{mot, new}} - V_{iN}}{V_{\text{mot}} - V_{iN}} \cdot M_{\text{limit}}$$

- P4 $M_{\text{limit, new}}$
The shifted voltage limiting characteristic is obtained with points P2 and P4.

Example for shifting the voltage limiting characteristic with motor 1FK7032-5AK71

$V_{\text{mot, new}} = 290 \text{ V}$; $V_{\text{iN}} = 6 \cdot 42 \text{ V}$; calculated with $V_{\text{mot}} = 425 \text{ V}$

Condition: $V_{\text{mot, new}} > V_{\text{iN}}$ is fulfilled.

Calculation P1: $n_1 = \frac{425}{42} \cdot 1000 \text{ RPM} = 10120 \text{ RPM}$

Calculation P2: $n_2 = \frac{290}{425} \cdot 10120 \text{ RPM} = 6905 \text{ RPM}$

Calculation P3: M_{limit} for $= 425 \text{ V}$ and read $n_{\text{N}} = 6000 \text{ RPM}$

Calculation P4: $M_{\text{limit, new}} = \frac{290 - 252}{425 - 252} \cdot 3 \text{ Nm} = 0.66 \text{ Nm}$

Enter points P2 and P4 and connect. This line is the new drive converter output voltage $V_{\text{mot, new}}$.

Rated speed n_{N}

The characteristic speed range for the motor is defined in the speed-torque diagram using the rated speed.

Stall torque M_0

Thermal limit torque at motor standstill corresponding to a utilization according to 100 K or 60 K. This can be output for an unlimited time at $n = 0$. M_0 is always greater than the rated torque M_{N} .

Stall current I_0

Motor phase current to generate the particular stall torque.

For 1FT6 and 1FK□ motors, sinusoidal rms currents are specified.

Rated torque M_{N}

Thermally permissible continuous torque for S1 duty at the rated motor speed.

Rated current I_{N}

rms motor phase current in order to generate the particular rated torque.

Max. current $I_{\text{max, rms}}$

This current limit is only determined by the magnetic circuit. Even if this is briefly exceeded, it can result in an irreversible de-magnetization of the magnetic material.

Maximum speed $n_{max, mech}$

The maximum permissible mechanical speed is n_{max} . It is defined by the centrifugal forces and frictional forces in the bearings.

Maximum torque M_{max}

Torque which is generated at the maximum permissible current.

The maximum torque is briefly available for high-speed operations (dynamic response to quickly change loads).

The maximum torque is limited by the control parameters. If the current is increased, then the rotor will be de-magnetized.

Optimum speed n_{opt}

Speed at which the optimum motor power is output (refer to to the following diagram).

Optimum power P_{opt}

Power which is reached at the optimum speed.

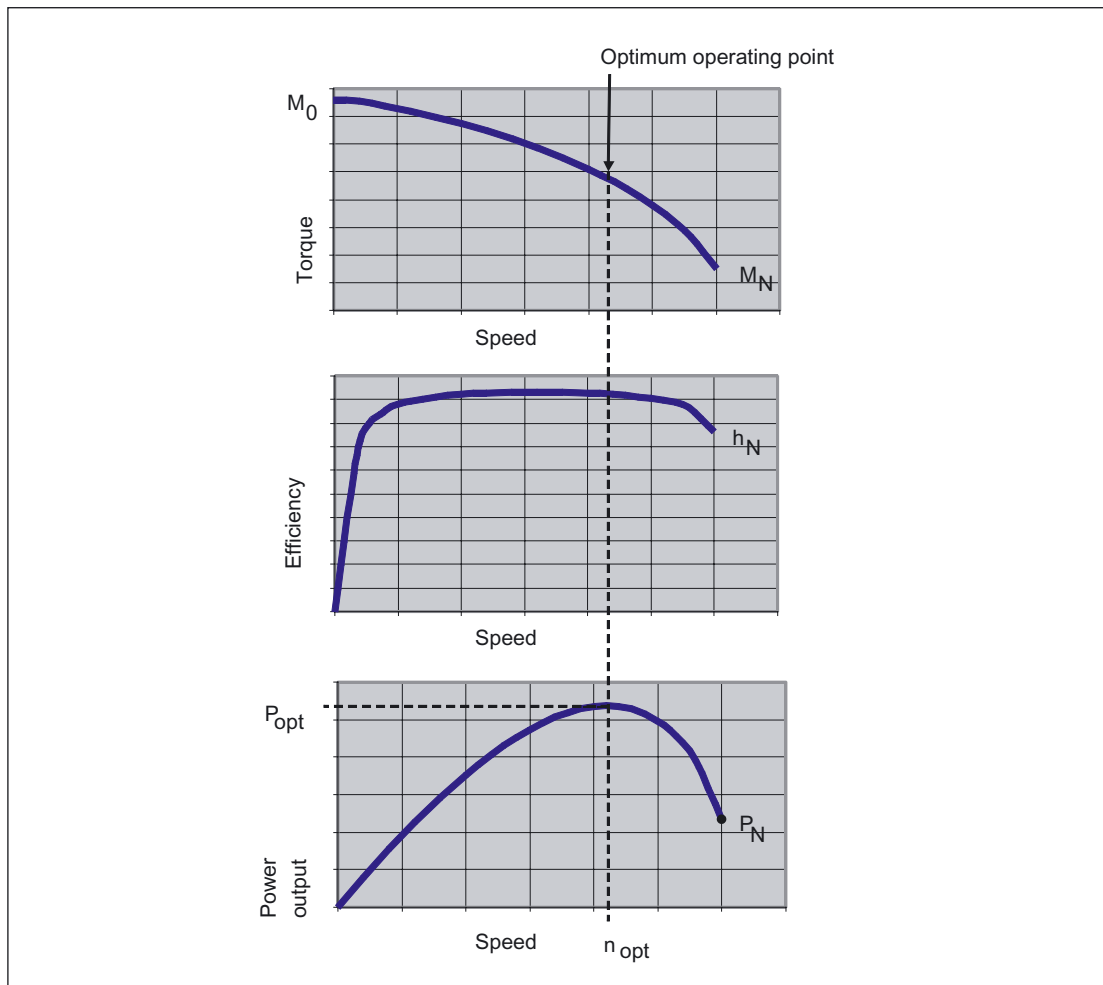

Figure 1-5 Optimum operating point

Typical M/I characteristic

The individual characteristics of the 1FT□ and 1FK□ motor series have been combined in "typical shaft height ranges".

The left-hand characteristic of the corresponding shaft height can be considered as "best case" - the right-hand characteristic as the "worst case".

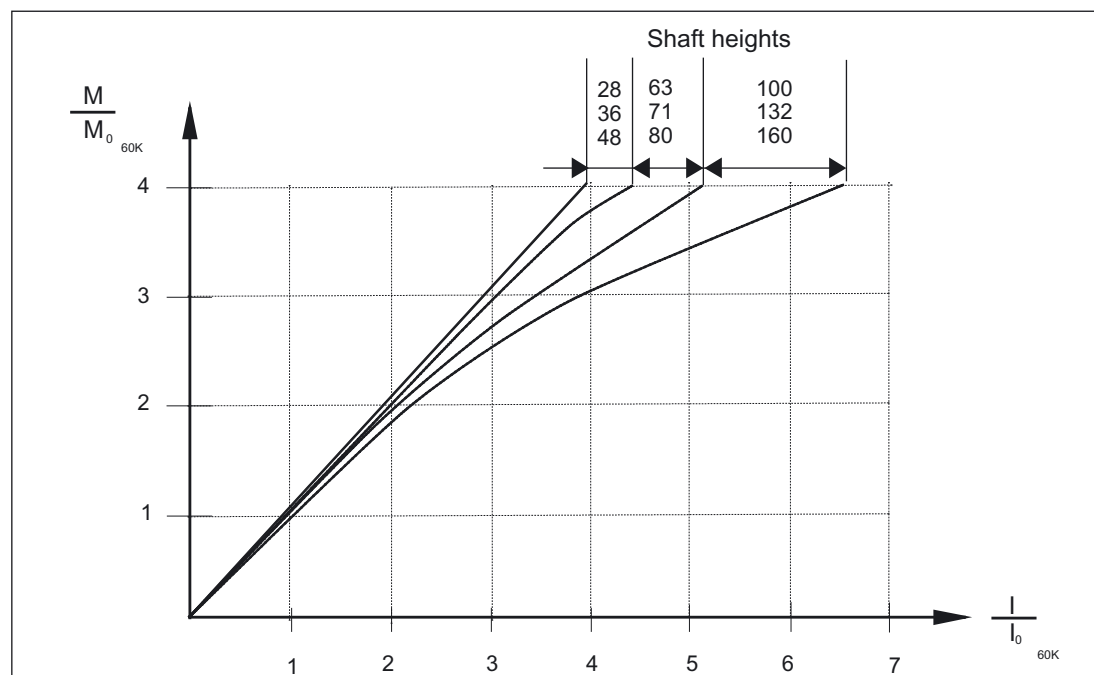

Figure 1-6 Typical torque-current characteristic for various shaft heights for naturally-ventilated motors with the same temperature rise

Torque constant k_T (value for a 100 K average winding temperature rise)

Quotient of the stall torque and stall current for a 20 °C ambient temperature.

Calculation:

$$k_T = M_{0,100K} / I_{0,100K}$$

The constant applies up to approx. $2 \cdot M_0$
(for 60 K and naturally-ventilated motors)

Note

These constants are not applicable when determining the necessary rated and accelerating currents (motor losses!).

The steady-state load and the frictional torques must also be included in the calculation.

Voltage constant k_E (value for an average winding temperature rise of 20 K)

Value of the induced motor voltage at a speed of 1000 RPM at an ambient temperature of 20 °C.

The phase-to-phase rms motor terminal voltage is specified for FK□/1FT6.

Winding resistance R_{ph}

The resistance of a phase at a room temperature of 20 °C is specified. The winding has a star circuit configuration.

Inductance L_D

The rotating field inductance is specified.

Electrical time constant T_{el}

Quotient obtained from the rotating field inductance and winding resistance. $T_{el} = L_D/R_{ph}$

Thermal time constant T_{th}

Defines the increase in the motor frame temperature when the motor load is suddenly increased (step function) to the permissible S1 torque. The motor has reached 63% of its final temperature after T_{th} .

Mechanical time constant T_{mech}

The mechanical time constant is obtained from the tangent at a theoretical ramp-up function through the origin.

$$T_{mech} = 3 \cdot R_{ph} \cdot J_{mot}/k_T^2 \text{ [s]}$$

$$J_{mot} = \text{Servomotor moment of inertia [kgm}^2\text{]}$$

$$R_{ph} = \text{Phase resistance of the stator winding [Ohm]}$$

$$k_T = \text{Torque constant [Nm/A]}$$

Moment of inertia J

The moment of inertia of the motor is described in the motor sections.

Shaft torsional stiffness C_T

This specifies the shaft torsional stiffness from the center of the rotor core to the center of the shaft end.

Brake resistor R_{opt}

R_{opt} corresponds to the optimum resistance value per phase, externally switched in series with the motor winding for armature short-circuit braking.

Braking torque $M_{b, opt}$

$M_{b, opt}$ corresponds to the average, optimum braking torque which is achieved using the series brake resistor R_{opt} .

Tolerance data

(data going beyond this are subject to a specific measuring accuracy)

Table 1-2 Tolerance data in the motor list data

Motor list data		Typ. value	Theoretical value
Stall current	I_0	± 3 %	± 7.5 %
Electrical time constant	T_{el}	± 5 %	± 10 %
Torque constant	k_T	± 3 %	± 7.5 %
Voltage constant	k_E	± 3 %	± 7.5 %
Winding resistance	R_{ph}	± 5 %	± 10 %
Moment of inertia	J_{mot}	± 2 %	± 10 %

Mechanical Data

2.1 Definitions

Types of construction (acc. to IEC 60034-7)

Standard for 1FK□ motors:		IM B5
Standard for 1FT□ motors:	SH 28 to 100:	IM B5
	SH 132 to 160:	IM B5, IM B35 (refer to Catalog)

Without having to be specifically ordered, the motors can also be used in the following types of construction:

for 1FK□	SH 28 to 100	IM V1, IM V3
for 1FT□	SH 28 to 100	IM V1, IM V3
for 1FT□	SH 132 to 160	IM V15, IM V36

The types of construction IM V1, IM V3, IM V15 and IM V36 are only available for parts of the 1FT6 product range (refer to the Catalog).

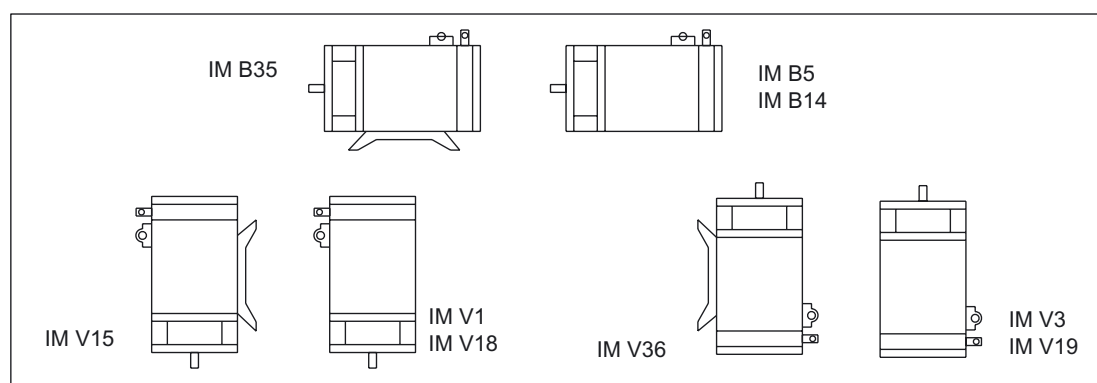

Figure 2-1 Types of construction

Note

When engineering motors, types of construction IM V3, IMV19 and IM V36, the permissible axial forces (force due to the weight of the drive-out elements) and especially the necessary degree of protection must be carefully observed.

Threaded inserts are included in the retaining holes for the following types of construction: IM B14, IM V18 and IM V19

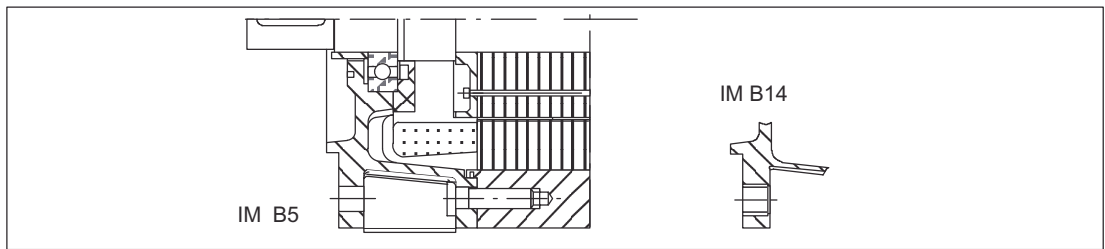

Figure 2-2 Type of construction IM B5/IM B14 (with metric threaded insert)

Surface temperature

The surfaces of synchronous motors can have temperatures > 100 °C. When required, protective measures must be provided to prevent coming into contact with the motors.

Storage

The bearings are sealed at both sides and are permanently lubricated. The bearings are designed for a minimum ambient temperature in operation of -15 °C.

Note

We recommend that the bearings are replaced after approx. 20 000 operating hours, however, at the latest after 5 years.

Shaft end

The cylindrical shaft ends according to DIN 748. IEC 60072 can either be ordered with or without keyway. The force-locked shaft-hub couplings are preferred for fast acceleration and reversing operation of the drives.

Mechanical turning

It is not possible to mechanically move the axis at the non-drive end of the motor. If the drive is to be manually rotated, then this should be done at the most accessible position (e.g. ball screw spindle).

Radial eccentricity, concentricity and axial eccentricity

The motors are tested in compliance with DIN 42955, IEC 60072.

Noise (acc. to DIN 45635)

The noise levels apply for operation when connected to SIMODRIVE 611 and MASTERDRIVES MC.

Table 2-1 Noise

Shaft height	Measuring surface sound pressure level under no-load conditions dB (A) for speeds 0 RPM up to n_N		
	Naturally-ventilated	Forced-ventilated	Water-cooled
28, 36	55	–	–
48	55	–	–
63	70	–	70
80	70	70	70
100	70	70	70
132	70	74	70
160	–	74	70

Vibration severity (acc. to EN 60034-14, IEC 60034-14)

The specified values only refer to the motor. These values can be increased at the motor due to the overall vibration characteristics of the complete system after the drive has been mounted.

The speeds of 1800 RPM and 3600 RPM and the associated limit values are defined in accordance with EN 60034-14. The speeds of 4500 RPM and 6000 RPM and the specified values are defined by the motor manufacturer.

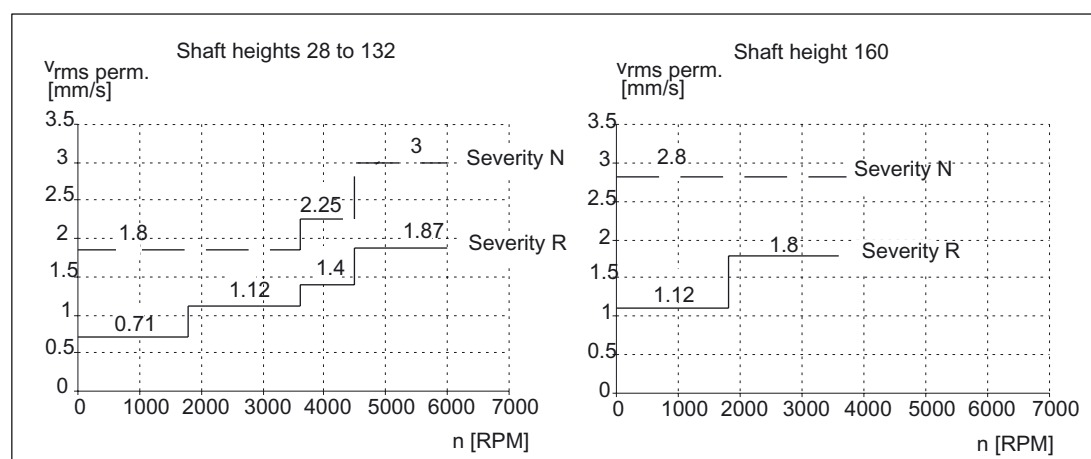

Figure 2-3 Characteristics of the vibration severity grades - limit values

2.1 Definitions

Operation under vibrational conditions, shock stressing

In order to ensure perfect functioning and a long bearing lifetime, the vibration values specified according to ISO 10816 should not be exceeded.

Table 2-2 Vibration values

Vibrational velocity V_{rms} (mm/s) acc. to DIN ISO 10816	Frequency f (Hz)	Acceleration a (m/s ²)
4.5	10	0.4
4.5	250	10

Deviating from the specified standard, motors 1FK702□ to 1FK710□ and 1FT602□ to 1FT610□ may be operated with higher loads but taking into account that the lifetime will be reduced. In this case, only operation outside the natural frequency is permissible.

Peak acceleration	Axial 20 m/s ²	Radial 50 m/s ²
Shock duration	3 ms	3 ms

Balancing (acc. to DIN ISO 8821) for motors with keyway

Motors with key in the shaft are half-key balanced. A mass equalization for the protruding half key must be taken into account for the drive-out elements.

Cantilever force/axial force stressing

Refer to the appropriate motor Planning Guide for a description and diagrams.

Paint

Table 2-3 Paint finish for 1FT□ and 1FK□

1FT□	1FK□
Anthracite (similar to RAL 7016) Two component epoxy resin paint; An additional paint finish is not required when the motors are used in sub-tropical regions.	Without paint finish Option: with paint finish (anthracite) The motors must be ordered with a special paint finish if they are to be used in sub-tropical regions and if they are to be transported by sea. This paint finish prevents the stator core from corroding.

Degree of protection (acc. to EN 60034-5)

The motors are available in various degrees of protection. Refer to Table "Selecting the motor degree of protection"

For motors with forced ventilation, the separately-driven fan is only available in degree of protection IP 54. All of the seals are manufactured from fluoride rubber (FPM).

2.2 Selecting the motor degree of protection

Degree of protection

The degree of protection designation according to EN 60034-5 and IEC 60034-5 consists of the letters "IP" and two digits (e.g. IP64). The second digit in the designation represents the protection against water, the first digit the protection against penetration of foreign matter.

Since coolants are used for machine tools and transfer machines that contain oil, are able to creep, and may also be corrosive, protection against water alone is insufficient. The designation for the degree of protection should only be considered here as a guideline. Our sealing systems are based on many years of practical experience, exceed the IEC definitions by far, and are appropriate for the requirements of machine tools.

The table can serve as a decision aid for selecting the proper degree of protection for servomotors. For types of construction IM V3/IM V19, liquid may only be present at the flange for IP67.

Table 2-4 Selecting the motor degree of protection

Liquid	General workshop environment	Water; General cooling-lubricating medium (95 % H ₂ O; 5 % oil); oil	Penetrating oil; Petroleum; Aggressive cooling-lubricating medium
Effect			
Dry	IP64	-	-
Water-enriched environment	-	IP64 ¹⁾	IP67 ²⁾
Mist	-	IP65	IP67
Spatter	-	IP65	IP68
Jet	-	IP67	IP68
Wave; brief immersion; continuous flooding (deckwater)	-	IP67	IP68

- 1) IP67 for versions with holding brake and oil as cooling medium
- 2) IP 64 for dry running at the shaft outlet

2.2 Selecting the motor degree of protection

Table 2-5 Overview, motor shaft sealing

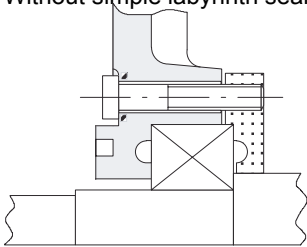
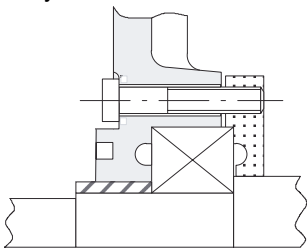
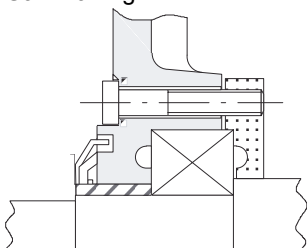
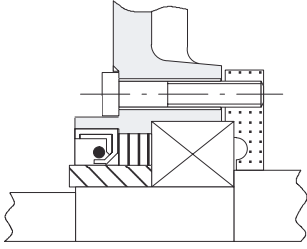
Degree of protection EN 60034-5	Shaft sealing using	Applications
IP64 (for 1FK□)	Without simple labyrinth seal 	It is not permissible that there is any moisture in the area around the shaft and the flange. Note: For IP 64 degree of protection it is not permissible that liquid collects in the flange. Shaft outlet is not dust tight
IP64 (for 1FT□)	Labyrinth seal 	It is not permissible that there is any moisture in the area around the shaft and the flange. Note: For IP 64 degree of protection it is not permissible that liquid collects in the flange. Shaft outlet is not dust tight
IP65 (only for 1FT6)	Gamma ring 	Shaft outlet seal to protect against spray water and cooling-lubricating medium. It is permissible that the Gamma ring runs dry. Lifetime 20 000 h (nominal value). For IP65 degree of protection it is not permissible that liquid collects in the flange.
IP65 ¹⁾ for 1FK□ IP67 ²⁾ (for 1FT□)	Radial shaft seal DIN 3760 	For gearbox mounting (for gearboxes which are not sealed) to seal against oil. The sealing lip must be adequately cooled and lubricated by the gearbox oil in order to guarantee reliable function. Lifetime 5000 h - 10000 h (nominal value) If a radial shaft sealing ring runs dry, then this has a negative impact on the functionality and the lifetime.
IP68 ²⁾ (only for 1FT6)	Refer to IP 67; in addition, a wetting sealing agent is used at the mechanical interfaces to the frame.	Refer to IP 67

1) For 1FK7, DE flange, IP67

2) For 1FT6, sealing air connection in the cover at the non-drive end (this can be used as an additional sealing measure when the motors are operated in extremely moisture/humid environments)

2.3 Cooling

Cooling versions

1FT□ and 1FK□ motors can be supplied with the following cooling versions:

Table 2-6 Cooling versions of 1FT□ and 1FK□ motors

Motor types	Natural ventilation	Forced ventilation	Water cooling
9th position of the motor Order No. (MLFB)	A	S	W
1FT6 SH 28, 36, 48	X		
1FT6 SH 63	X		X
1FT6 SH 80, 100, 132, 160	X	X	X
1FK□	X		

Natural ventilation/forced ventilation

Operating temperature range: -15 °C to +40 °C (without any restrictions).

The power loss is dissipated through radiation and natural convection which means that adequate heat dissipation must be ensured by suitably mounting the motor.

All of the Catalog data refer to an ambient temperature of 40 °C, mounted so that the motors are not thermally insulated and an installation altitude up to 1000 m above sea level.

If other conditions prevail (ambient temperature > 40 °C or installation altitude > 1000 m above sea level), the permissible torque/power must be defined using the factors from the following table (torque/power reduction according to EN 60034-6).

Ambient temperatures and installation altitudes are rounded-off to 5 °C or 500 m respectively.

Table 2-7 Power de-rating as a function of the installation altitude and the ambient temperature

Installation altitude above sea level [m]	Ambient temperature in °C					
	< 30	30–40	45	50	55	60
1000	1.07	1.00	0.96	0.92	0.87	0.82
1500	1.04	0.97	0.93	0.89	0.84	0.79
2000	1.00	0.94	0.90	0.86	0.82	0.77
2500	0.96	0.90	0.86	0.83	0.78	0.74
3000	0.92	0.86	0.82	0.79	0.75	0.70
3500	0.88	0.82	0.79	0.75	0.71	0.67
4000	0.82	0.77	0.74	0.71	0.67	0.63

Configuration

3.1 Engineering software

3.1.1 NCSD Configurator

Intelligent selection tool to engineer SINUMERIK and SIMODRIVE components

Customized plants and systems can be simply and quickly engineered - from selecting the CNC control through the assignment of the operator components up to the drive configuration.

Benefits

- Simple tree-like structure and transparent navigation
- Variable module selection and sequence
- Configuration of sub-components and total plants and systems
- The order can be optimized by immediately re-calculating when changes are made to the configuration
- All of the selected components are continuously checked for consistency and that they can actually be used in conjunction with one another
- A parts list that has been generated can be transferred into the interactive Catalog CA 01
- The parts list can be completed by freely entering Order Nos.
- Languages: German, English, French, Italian and Spanish

CNC control, operator components, HMI software, SIMATIC S7-300 I/O, converter system, motors and measuring system are selected in a harmonized unified way as overall system. Motors can be selected using the Order No. or using a motor Wizard by specifying the speed, torque and power rating. The motor is automatically assigned to the matching power module and the appropriate cables. The cable length can then be defined as a function of the application.

The NCSD Configurator provides information about:

- Design and configuration of the SINUMERIK components
- Design and configuration of the SIMODRIVE group
- Motor data and options for core motor types
- The DC link power and capacitance
- Evaluation points (electronic and gating points)
- Calculating the power loss for cabinet components

Software update service, repair service contract, documentation and service/maintenance contracts for the individual components are also implemented in the NCSD Configurator.

You can obtain the NCSD Configurator as follows:

- Together with the interactive CA 01 Catalog, or
- Continually updated on the Internet under:

<http://www.siemens.com/sinumerik>

3.1.2 PATH Plus engineering tool

Using the PATH Plus engineering program, three-phase variable-frequency drives can be simply and quickly engineered for the SIMOVERT MASTERDRIVES Vector Control and Motion Control series.

The program is a powerful engineering tool that supports the user in all of the engineering steps - from the supply to the motor.

A menu-prompted program helps you select and dimension frequency converters, system components and the required motor for a particular drive application. Information and instructions that are automatically displayed guarantee error-free design and planning.

Entry level personnel are also supported in understanding how to use the program using a comprehensive help system. PATH Plus navigates and guides the design engineer to achieve reliable, reproducible and cost-effective drive engineering. It starts from the mechanical requirements of the driven machine and the drive application itself using a procedure of dialogs that are logical and simple to handle. The technical data of the selected frequency converters and motors, the selected system components and the necessary accessories are listed in detail.

PATH Plus allows drive to be engineered starting from a load characteristic or from a load duty cycle and allows applications such as the following to be engineered:

- Traversing and hoisting gears
- Swiveling gears
- Spindle drive
- Axial winders and
- Crank drives.

PATH Plus includes a user-friendly tool to graphically display the following characteristics:

- Torque, speed, power, current, velocity and acceleration over time, and
- Torque with respect to speed.

Harmonics fed back into the line supply are calculated and graphically displayed.

The engineering results can be saved on a data medium, printed-out or copied into other user programs for ongoing processing and editing through the clipboard.

PATH Plus is available with German/English user interfaces and screens.

The demonstration version of PATH Plus can be downloaded under the following Internet address:

<http://www.siemens.com/motioncontrol>

(Products&Systems/Drive systems/Software), or simply use the fax form in the Appendix of the Manual.

The full version of PATH Plus can be ordered from your local Siemens office under Order No. 6SW1710-0JA00-2FC0.

3.2 Procedure when engineering

Motion Control

Servo drives are optimized for motion control applications. They execute linear or rotary movements within a defined movement cycle. All movements should be optimized in terms of time.

As a result of these considerations, servo drives must meet the following requirements:

- High dynamic response, i.e., short rise times
- Capable of overload, i.e. a high reserve for accelerating
- Wide control range, i.e. high resolution for precise positioning.

The following engineering procedure is valid for synchronous and asynchronous motors.

General procedure when engineering

The function description of the machine provides the basis when engineering. The definition of the components is based on physical interdependencies and is usually carried-out as follows:

	Step	Description of the engineering activity
Refer to the following Chapter	1.	The type of drive/infeed type is clarified
	2.	Definition of supplementary conditions and integration into an automation system
	3.	The load is defined, the max. load torque is calculated, the motor selected
Refer to the converter catalog	4.	Selecting the SIMOVERT MASTERDRIVES MC Motor Modules
	5.	Steps 3 and 4 are repeated for additional axes
	6.	Calculation of the required DC link power and definition of the SIMOVERT MASTERDRIVES MC Line Modules
	7.	The line-side options (main switch, fuses, line filters, etc.) are selected
	8.	Specification of the required control performance and selection of the SIMOVERT MASTERDRIVES MC Control Unit, defining and selecting the component wiring
	9.	Additional system components are defined and selected
	10.	The current demand of the 24 V DC supply for the components is calculated and the power supplies (SITOP devices, control supply modules) specified
	11.	The components for the connection system are selected
	12.	The components of the drive group are configured to form a complete drive

3.3 Dimensioning

3.3.1 1. Clarification of the type of drive

The motor is selected on the basis of the required torque, which is defined by the application, e.g. traveling drive, hoisting drive, feed drive or main spindle drive. Gear units to convert motion or to adapt the motor speed and motor torque to the load conditions must also be considered.

As well as the load torque, which is determined by the application, the following mechanical data are among those required to calculate the torque to be provided by the motor:

- Masses to be moved
- Diameter of the drive wheel/diameter
- Leadscrew pitch, gear ratios
- Frictional resistance
- Mechanical efficiency
- Traversing paths
- Maximum velocity
- Maximum acceleration and maximum deceleration
- Cycle time

3.3.2 2. Definition of supplementary conditions and integration into an automation system

You must decide whether synchronous or induction motors are to be used.

Synchronous motors are the best choice if it is important to have low envelope dimensions, low rotor moment of inertia and therefore maximum dynamic response.

Induction motors can be used to increase maximum speeds in the field weakening range. Induction motors for higher power ratings are also available.

You should also specify whether the drives are to be operated as single-axis drives or in a group as multi-axis drives.

The following factors are especially important when engineering a drive application:

- The type of line supply, when using specific types of motor and/or line filters on IT line supply systems (non-grounded systems)
- The utilization of the motor in accordance with rated values for winding temperatures of 60 K or 100 K
- The ambient temperatures and the installation altitude of the motors and drive components.

Other boundary conditions apply when integrating the drives into an automation environment such as SIMATIC or SIMOTION.

For motion control and technology functions (e.g. positioning), as well as for synchronous functions, the corresponding automation system, e.g. SIMOTION D, is used.

The drives are interfaced to the higher-level automation system via PROFIBUS.

3.3.3 3. Definition of the load, calculation of max. load torque, definition of the motor

The motor-specific limiting curves are used as basis when selecting a motor.

These define the torque characteristic with respect to speed and take into account the motor limits based on the line supply voltage and the function of the infeed.

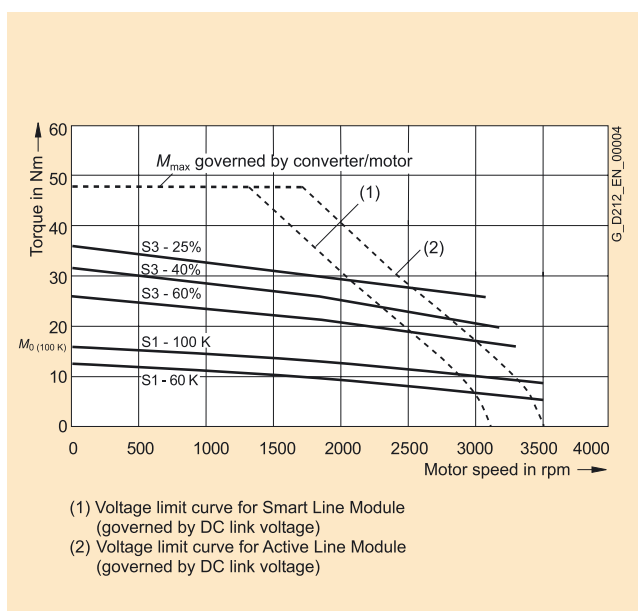

Figure 3-1 Limiting curves for synchronous motors (example)

The motor is selected based on the load which is specified by the application. Different characteristics must be used for different loads.

The following operating scenarios have been defined:

- Load duty cycles with constant on period
- Load duty cycles with varying on period
- Load duty cycle

The objective is to identify characteristic torque and speed operating points, on the basis of which the motor can be selected depending on the particular load.

Once the operating scenario has been defined and specified, the maximum motor torque is calculated. Generally, the maximum motor torque is required when accelerating. The load torque and the torque required to accelerate the motor are added.

The maximum motor torque is then verified using the motor limiting curves.

The following criteria must be taken into account when selecting the motor:

- The dynamic limits must be observed, i.e., all speed-torque points of the load must lie below the relevant limiting curve.
- The thermal limits must be observed, i.e. for synchronous motors, the rms motor torque at the average motor speed resulting from the load duty cycle must lie below the S1 curve (continuous duty). For induction motors, the rms value of the motor current within a load duty cycle must be less than the rated motor current.
- For synchronous motors it should be observed that the maximum permissible motor torque is reduced at higher speeds as a result of the voltage limiting curve. In addition, a clearance of 10% from the voltage limiting curve should be observed to safeguard against voltage fluctuations.
- When using induction motors, the permissible motor torque in the field weakening range is reduced as a result of the stability limit. A clearance of 30% should be observed.
- When using an absolute encoder, the rated torque of the motor is reduced by 10% due to the thermal limits of the encoder.

Load duty cycles with constant on period

For load duty cycles with constant on period, specific requirements are placed on the torque characteristic as a function of the speed, e.g. $M = \text{constant}$, $M \sim n^2$, $M \sim n$ or $P = \text{constant}$.

These drives typically operate at a specific operating point. Drives such as these are dimensioned for a base load. The base load torque must lie below the S1 curve.

In the event of transient overloads (e.g. when accelerating) an overload has to be taken into consideration. The peak torque must lie below the voltage limiting curve for synchronous motors or below the stability limit for induction motors.

In summary, the motor is selected as follows:

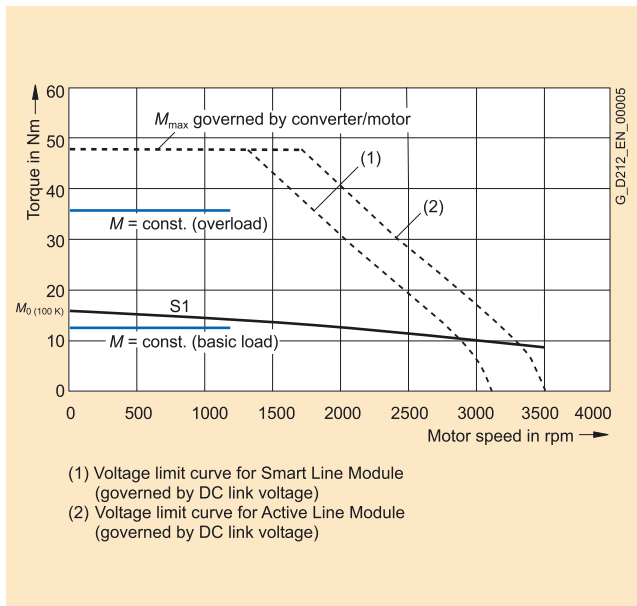

Figure 3-2 Selection of motors for load duty cycles with constant on period (examples)

Load duty cycles with varying on period

As well as continuous duty (S1), standard intermittent duty types (S3) are also defined for load duty cycles with varying on periods. This involves operation that comprises a sequence of similar load cycles, each of which comprises a time with constant load and an off period.

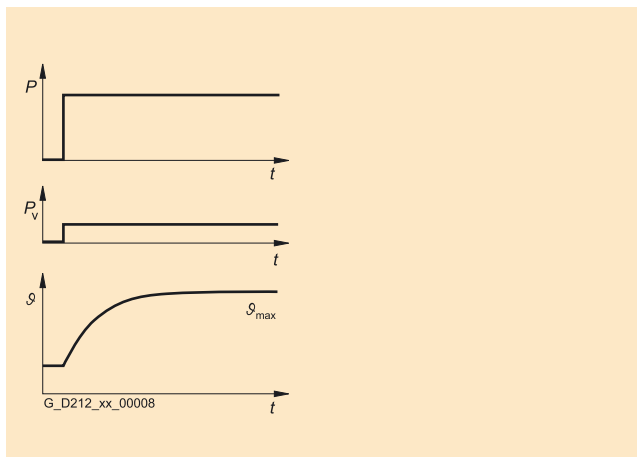

Figure 3-3 S1 duty (continuous operation)

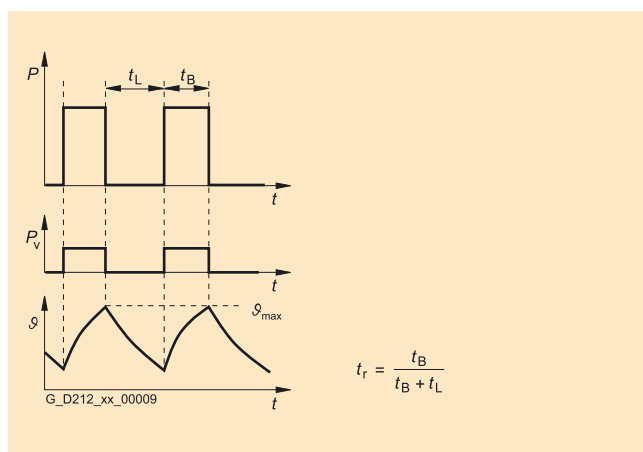

Figure 3-4 S3 duty (intermittent operation without influencing starting)

Fixed variables are usually used for the relative on period:

- S3 – 60%
- S3 – 40%
- S3 – 25%

The corresponding motor characteristics are provided for these specifications. The load torque must lie below the corresponding thermal limiting curve of the motor. An overload must be taken into consideration for load duty cycles with varying on periods.

In summary, a motor is selected as follows:

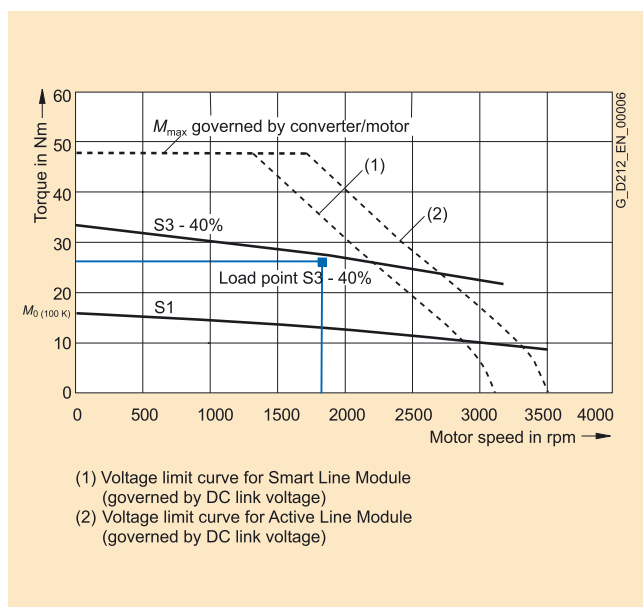

Figure 3-5 Selecting motors for load duty cycles with varying on periods using a synchronous motor as an example

Load duty cycle

A load duty cycle defines the characteristics of the motor speed and the torque with respect to time.

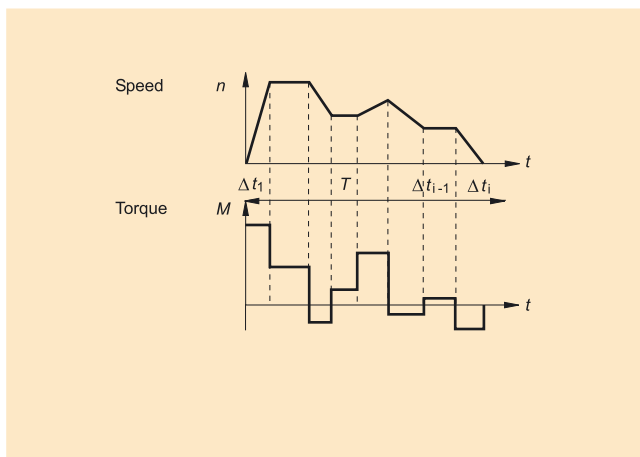

Figure 3-6 Example of a load duty cycle

A load torque is specified for each time period. In addition to the load torque, the average load moment of inertia and motor moment of inertia must be taken into account for acceleration. It may be necessary to take into account a frictional torque that opposes the direction of motion.

The gear ratio and gear efficiency must be taken into account when calculating the load and/or accelerating torque to be provided by the motor. A higher gear ratio increases positioning accuracy in terms of encoder resolution. For any given motor encoder resolution, as the gear ratio increases, so does the resolution of the machine position to be detected.

For more information about gear units, see the motor descriptions.

For the motor torque in a time slice Δt_k the following applies:

$$M_{\text{mot}, i} = (J_M + J_G) \cdot \frac{2\pi}{60} \cdot \frac{\Delta n_{\text{load}, i}}{\Delta t_i} \cdot i + \left(J_{\text{load}} \cdot \frac{2\pi}{60} \cdot \frac{\Delta n_{\text{load}, i}}{\Delta t_i} + M_{\text{load}, i} + M_{\text{fr}} \right) \cdot \frac{1}{i \cdot \eta_G}$$

The motor speed is:

$$n_{\text{mot}, i} = n_{\text{load}, i} \cdot i$$

The rms torque is obtained as follows:

$$M_{\text{mot}, \text{rms}} = \sqrt{\frac{\sum M_{\text{mot}, i}^2 \cdot \Delta t_i}{T}}$$

The average motor speed is calculated as follows:

$$n_{\text{mot, average}} = \frac{\sum \frac{n_{\text{mot, k, A}} + n_{\text{mot, k, E}}}{2} \cdot \Delta t_i}{t_e}$$

J_M	Motor moment of inertia
J_G	Gearbox moment of inertia
J_{load}	Load moment of inertia
N_{load}	Load speed
i	Gear ratio
η_G	Gearbox efficiency
M_{load}	Load torque
M_R	Friction torque
T	Cycle time, clock cycle time
I;F	Initial value, final value in time slice Δt_i
t_e	Power-on duration

The rms torque M_{rms} must lie below the S1 curve.

The maximum torque M_{max} is required when the drive is accelerating and for synchronous motors must lie below the voltage limiting curve and for induction motors below the stability limit.

In summary, the motor is selected as follows:

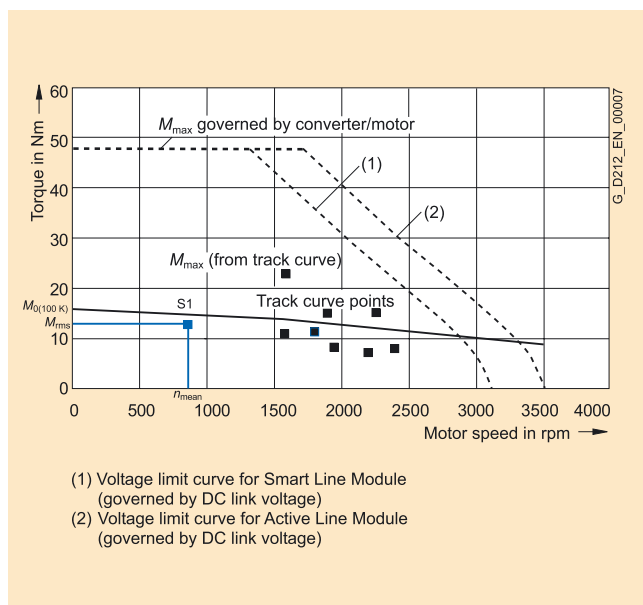

Figure 3-7 Selecting motors depending on the load duty cycle (example)

Motor selection

By making the appropriate iterations, a motor can now be selected that precisely fulfills the operating conditions and application.

In a second step, a check is made as to whether the thermal limits are maintained. To do this, the motor current at the base load must be calculated. When engineering a drive according to the load duty cycle with a constant on period with overload, the overload current based on the required overload torque must be calculated. The calculation depends on the type of motor used (synchronous motor, induction motor) and the particular application (load duty cycles with constant on period, load duty cycles with varying on period, load duty cycle).

Finally, the other characteristics of the motor must be defined. This is realized by appropriately configuring the motor options.

Electrical Connections

4.1 Power cable



Caution

The synchronous motors are not designed to be directly connected to the line supply and may only be operated with the associated SIMODRIVE 611 or SIMOVERT MASTERDRIVES MC drive converters.

Carefully observe the rating plate data and adequately dimension the connecting cables (the appropriate tables are provided in the Instructions) and ensure that the cables are adequately strain relieved.

For safety-relevant circuits, each individual application must be carefully checked as to whether the internal control devices in the drive converter are adequate to provide the appropriate electrical isolation from the line supply.

All work should be undertaken only with the system in a no-voltage condition!

Cross-sections

Table 4-1 Current load capability acc. to EN 60204-1 for PVC insulated cables with copper conductors for an ambient temperature of 40 °C and routing type C (cables and conductors routed along walls/panels and in cable ducts).

I_{rms} [A]	Cross-section required [mm ²]	Remarks
15.2	1.5	Correction factors with reference to the ambient temperature and routing type are specified in EN60204-1.
21	2.5	
28	4	
36	6	
50	10	
66	16	
84	25	
104	35	
123	50	
155	70	

rms current:

$$1FT5: I_{rms} = I_0 \cdot \sqrt{\frac{2}{3}} \quad (\text{at standstill: } I_{rms} = I_0!)$$

$$1FT6/1FK\Box: I_{rms} = I_0$$

Caution

When engineering the system it must be checked to ensure that the power cable can be connected to the power module.

Assignment: Motor - cable cross-section - terminal box - power connector

The assignment: Motor - cable cross-section - terminal box - power connector is described in the appropriate Motor Configuration Manual.

4.2 Order Nos. for power cables

4.2.1 Overview

Prefabricated cables reduce the mounting/installation time and costs and increase the operational reliability.

Power cables available for synchronous motors:

- Prefabricated cable without brake conductors with overall shield
- Prefabricated cable with brake conductors with overall shield
- Cable sold by the meter without brake conductors with overall shield
- Cable sold by the meter with brake conductors with overall shield



Caution

Carefully observe the current which the motor draws for your particular application!
Adequately dimension the connecting cables according to IEC 60204-1.

Explanation of Order No. for the power cables

6FX	□	00	□	-	□□□□□	-	□□□	0
	↓		↓	↓			↓↓↓	
	↓		↓	↓			Length code	
	↓		↓	Type, cross-section, connector size				
	↓		2 = prefabricated					
	↓		8 = sold by the meter					
			5 = MOTION-CONNECT®500					
			8 = MOTION-CONNECT®800					

Length code

Table 4-2 Length codes for prefabricated cables

Cables, prefabricated					
Length code	6FX2002-.....-	<input type="checkbox"/>	<input type="checkbox"/>	<input type="checkbox"/>	0
	6FX5002-.....-	<input type="checkbox"/>	<input type="checkbox"/>	<input type="checkbox"/>	0
	6F82002-.....-	<input type="checkbox"/>	<input type="checkbox"/>	<input type="checkbox"/>	0
1 m – 99 m		1			
100 m – 199 m		2			
200 m – 299 m		3			
0 m			A		
10 m			B		
20 m			C		
30 m			D		
40 m			E		
50 m			F		
60 m			G		
70 m			H		
80 m			J		
90 m			K		
0 m				A	
1 m				B	
2 m				C	
3 m				D	
4 m				E	
5 m				F	
6 m				G	
7 m				H	
8 m				J	
9 m				K	

Examples:

- 1 m 6FX□00□-□□□□□-1AB0
- 2 m 6FX□00□-□□□□□-1AC0
- 5 m 6FX□00□-□□□□□-1AF0
- 10 m 6FX□00□-□□□□□-1BA0
- 15 m 6FX□00□-□□□□□-1BF0
- 18 m 6FX□00□-□□□□□-1BJ0
- 20 m 6FX□00□-□□□□□-1CA0
- 25 m 6FX□00□-□□□□□-1CF0
- 50 m 6FX□00□-□□□□□-1FA0
- 100 m 6FX□00□-□□□□□-2AA0
- 150 m 6FX□00□-□□□□□-2FA0

Definition of lengths for prefabricated cables

The cable length specified does not include the connector.

Note

For technical data and additional cable versions, refer to Catalog, Chapter MOTION CONNECT Connection System.

4.2.2 Prefabricated power cable without brake conductors

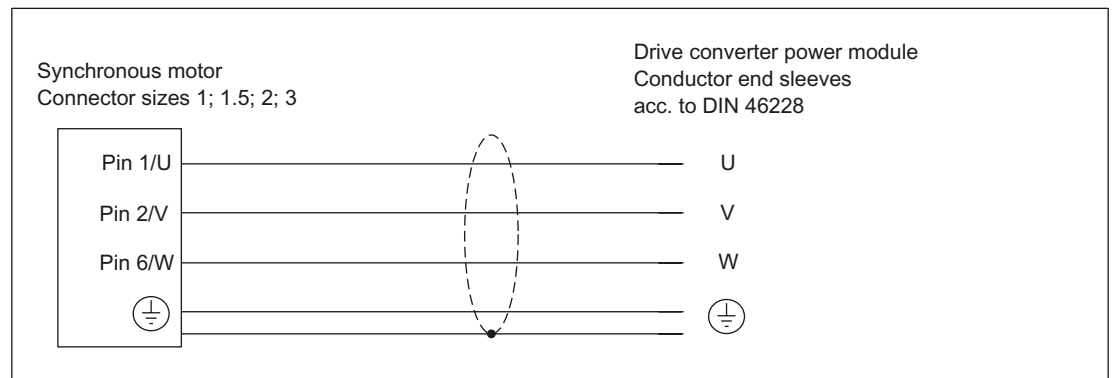

Figure 4-1 Prefabricated power cables without brake conductors with overall shield
Order No. 6FX0002-5CA00-0000

4.2.3 Prefabricated power cable with brake conductors

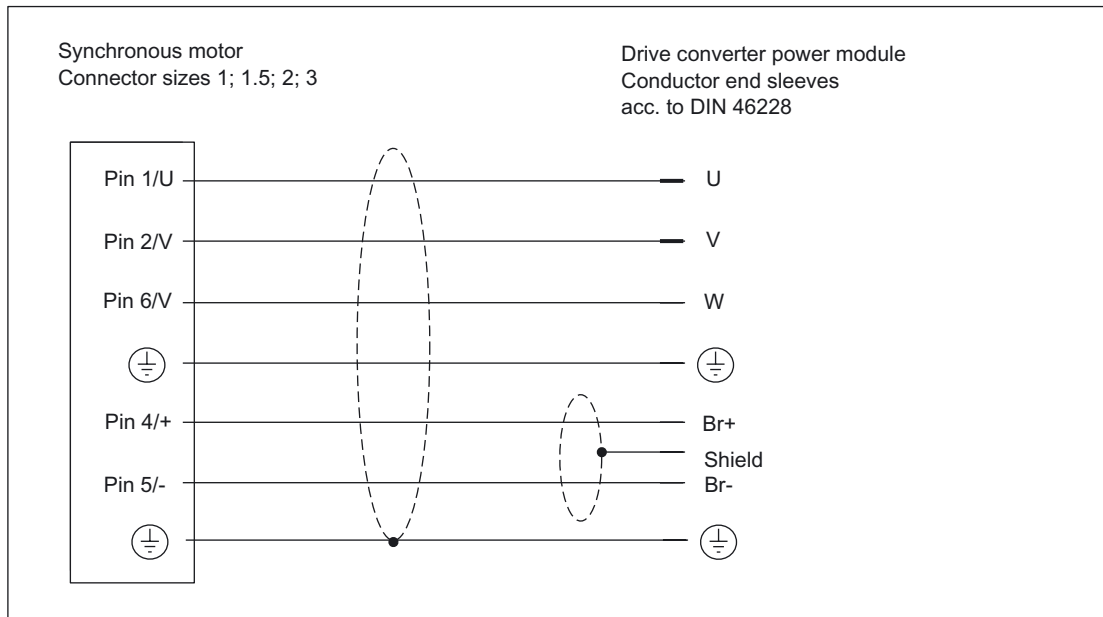

Figure 4-2 Prefabricated power cable with brake conductors with overall shield
Order No. 6FX□002-5DA□□-□□□0

4.2.4 Power cable sold by the meter without brake conductors

Order No.

6FX □ 008 - 1□ B□□ - □□□ 0
 ↓ ↓ ↓ ↓ ↓ ↓
 ↓ ↓ ↓ Length code
 ↓ ↓ Without brake conductors
 ↓ 8 = sold by the meter
 5 = MOTION-CONNECT@500
 8 = MOTION-CONNECT@800

4.2.7 Shielding



Caution

The overall system compatibility is only guaranteed when using shielded power and signal cables.

Shields must be incorporated in the protective grounding concept. Open-circuit or unused, conductors which can be touched, must be connected to protective ground. If the brake conductors in the SIEMENS cables are not used, then the brake conductors and shields must be connected to the cabinet ground. (open-circuit cables result in capacitive charges!).

Cable routing in a damp environment

Notice

If the motor is installed in a damp environment, the cables are to be routed as shown in the following figure.

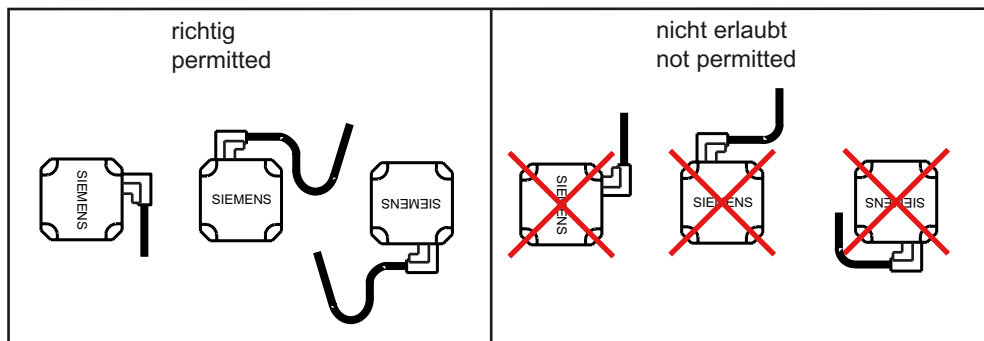

Figure 4-3 Cable routing in a damp environment

Motor Components

5.1 Influence of the mounting type and mounted components

Some of the motor power loss is dissipated through the flange when the motor is connected to the mounting flange.

Non-thermally insulated mounting

The following mounting conditions apply for the specified motor data:

Table 5-1 Non-thermally insulated mounting conditions

Shaft height	Steel plate width x height x thickness	Mounting surface [m ²]
28 to 48	120 x 100 x 40	0.012
63 to 160	450 x 370 x 30	0.17

For larger mounting surfaces, the heat dissipation conditions improve.

Thermally insulated mounting without additionally mounted components

For naturally-ventilated and force-ventilated motors, the motor torque must be reduced by between 5 % and 10 %. We recommend that the motor is engineered using the $M_0(60\text{ K})$ values.

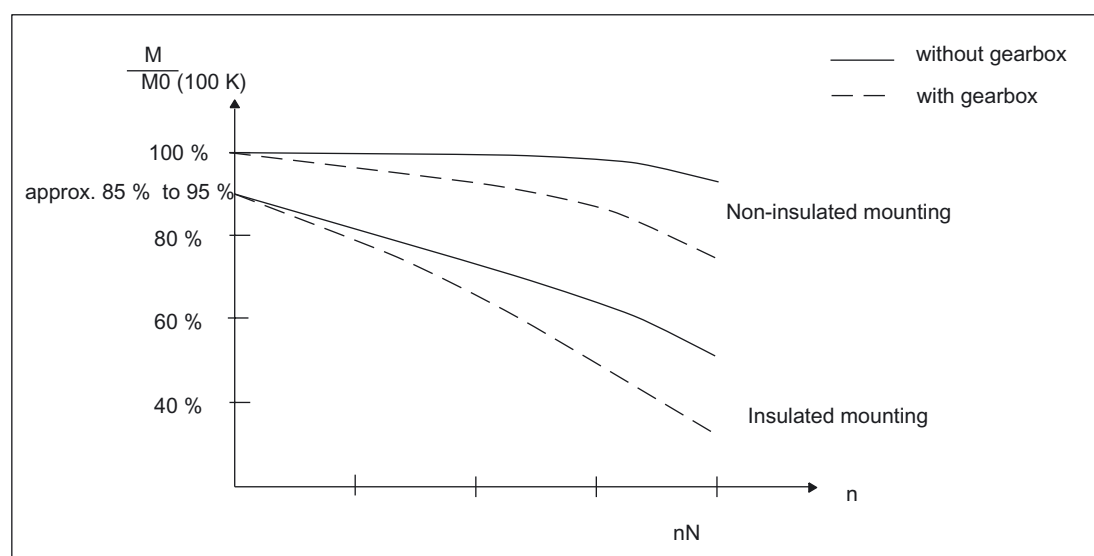

Figure 5-1 S1 characteristics

Thermally insulated mounting with additionally mounted components

- Holding brake (integrated in the motor)
The torque does not have to be additionally reduced
- Gearbox
The torque has to be reduced (refer to Fig. "S1 characteristics"))

5.2 Drive-out couplings

After investigating various drive-out couplings for servomotors in conjunction with Siemens drive converters, it was seen, that in many cases, the drive-out couplings were the cause of vibration problems. In order to achieve optimum drive-out characteristics, ROTEX-GS couplings from the KTR company should be used. The advantages of ROTEX-GS couplings include:

- 2 to 4x torsional stiffness of a belt-driven gearbox
- No intermeshing teeth (when compared to belt gearboxes)
- Low moment of inertia
- Good control behavior

When it comes to mounting, the clamping hub without key is considered to be adequate up to a coupling size of 38 and up to the specified torques that can be transferred (refer to the appropriate Motor Configuration Manual). It must be carefully noted that the friction locked torque must always be adequately dimensioned according to the assignment to the particular motor frame size. The accelerating torque also has to be transferred.

From a coupling size of 42 or as an alternative to the clamping hub, we can recommend the version with clamping ring hub. This means that the maximum coupling torque can be almost reached.

The investigations extend to include the vibration characteristics and behavior. The couplings assigned to the motors permit higher speed control loop gains and therefore result in the highest possible K_V values and uniform motion.

ROTEX GS couplings are available with 4 different plastic pinion gears with various Shore hardnesses:

- 98 or 95 Shore A (average)
- Alternatively: 92 Shore A
- Alternatively: 80 Shore A (soft)
- Alternatively: 64 Shore D (hard)

The adaptation to the existing machine masses and stiffness, which becomes possible, must be determined, taking into account the mounted mechanical system.

The gearboxes can be ordered from KTR; they can also provide information about the various products, delivery times and prices.

Address:	KTR Kupplungstechnik GmbH Rodder Damm 170 D-48432 Rheine
Postal address:	Postfach 1763 D-48407 Rheine
Tel. Engineering Dept.:	+49 (0) 5971 / 798 - 465 (337)
FAX:	+49 (0) 5971 / 798 - 450
Internet:	http://www.ktr.com

The Motor Configuration Manual provides information on the assignment of the drive-out couplings to the motors.

5.3 Armature short-circuit braking

For transistor PWM converters, when the DC link voltage values are exceeded or if the electronics fails, then electrical braking is no longer possible. If the drive which is coasting down, can represent a potential hazard, then the motor can be braked by short-circuiting the armature. Armature short-circuit braking should be initiated at the latest by the limit switch in the traversing range of the feed axis.

The friction of the mechanical system and the switching times of the contactors must be taken into account when determining the distance that the feed axis takes to come to a complete stop. In order to avoid mechanical damage, mechanical stops should be located at the end of the absolute traversing range.

For servomotors with integrated holding brake, the holding brake can be simultaneously applied to create an additional braking torque - however, with some delay.

Caution

The drive converter pulses must first be canceled and this actually implemented before an armature short-circuit contactor is closed or opened. This prevents the contactor contacts from burning and eroding and destroying the drive converter.



Warning

The drive must always be operationally braked using the setpoint input. For additional information, refer to the Drive Converter Configuration Manual.

Brake resistors

The optimum braking torque of the servomotor in regenerative operation can be obtained using armature short-circuit with a matching external resistor circuit.

The resistors which must be externally mounted are described in the appropriate Motor Configuration Manual.

Ordering address:	Fritzen GmbH & Co.KG Gottlieb-Daimler-Str. 61 71711 Murr Germany
Tel.:	+49 (0) 7144 / 2724 - 25

Rating

The resistor can be dimensioned so that a surface temperature of 300° C can occur briefly (max. 500 ms). In order to prevent the resistor from being destroyed, braking from the rated speed can occur max. every 2 minutes. Other braking cycles must be specified when ordering the resistors. The external moment of inertia and the intrinsic motor moment of inertia are decisive when dimensioning these resistors.

The kinetic energy must be specified when ordering in order to determine the resistor rating.

$$W = \frac{1}{2} \cdot J \cdot \omega^2$$

W in [Ws]

J in [kgm²]

ω in [s⁻¹]

Braking times and braking distances

The braking time is calculated using the following formula:

Braking time:

$$t_B = \frac{J_{\text{tot}} \cdot n_N}{9.55 \cdot M_B}$$

Moment of inertia J [kgm²]

Rated speed n_N [RPM]

Moment of inertia:

$$J_{\text{tot}} = J_{\text{mot}} + J_{\text{ext}}$$

Average braking torque M_B [Nm]

Braking time t_B [s]

Braking distance:

$$s = \frac{1}{2} V_{\text{max}} \cdot t_B$$

Braking distance s [m]

Velocity V_{max} [m/s]

Notice

When determining the run-on distance, then, for example, the friction (taken into account as allowance in M_B) of the mechanical transmission elements and the switching delay times of the contactors must be taken into consideration. In order to prevent mechanical damage, mechanical end stops should be provided at the end of the absolute traversing range of the machine axes.

5.3 Armature short-circuit braking

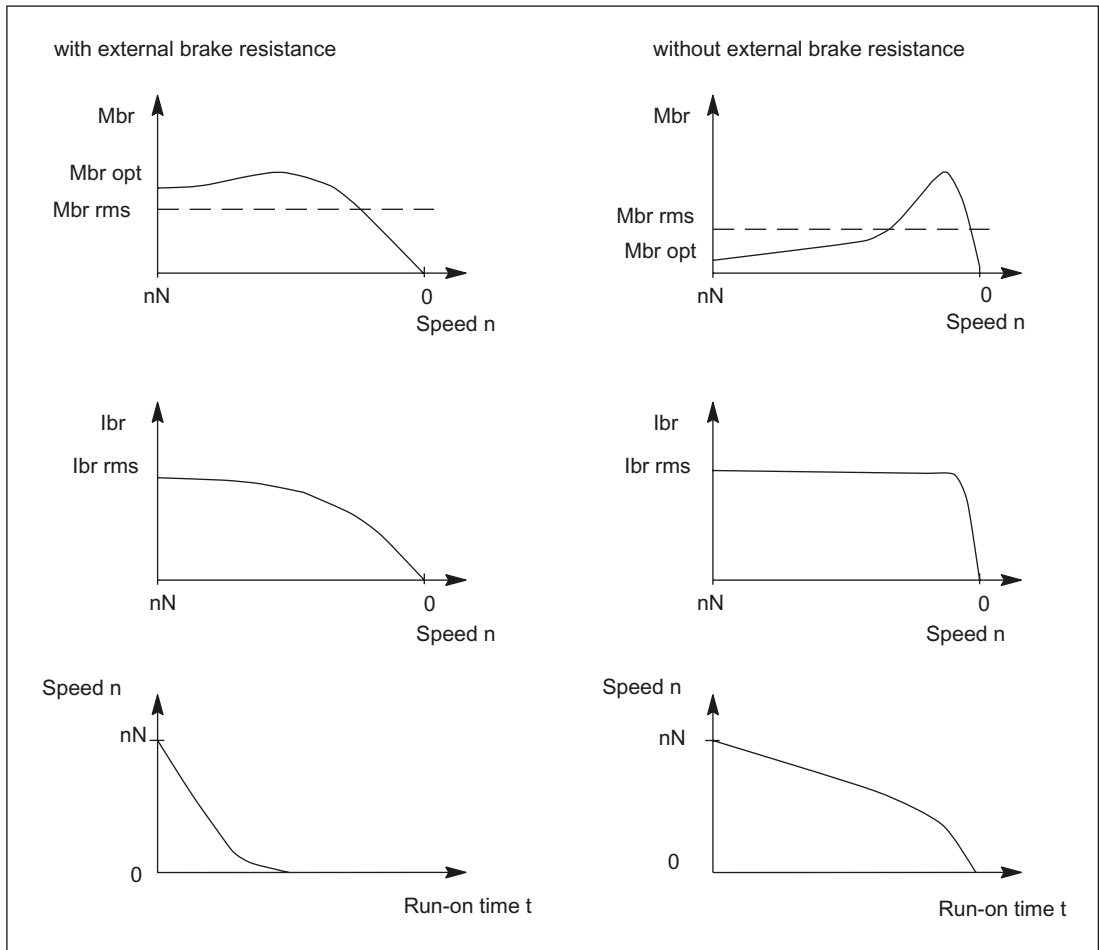

Figure 5-2 Armature short-circuit braking

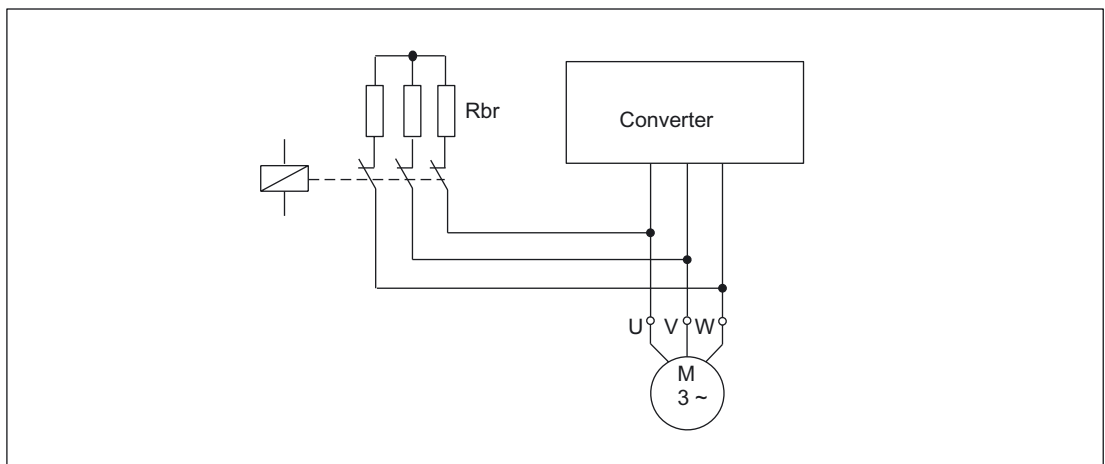

Figure 5-3 Circuit (principle) for armature short-circuit braking

5.4 Holding brake

Characteristics

- The integrated or mounted holding brake is used to clamp the motor shaft when the motor is at a standstill. The holding brake is **not** a working brake that is used to brake a motor that is still rotating.
- Motors with or without holding brake cannot be subsequently retrofitted! Motors with holding brake are longer by the mounted space required (refer to the dimension drawing).
- Restricted Emergency Stop operation is permissible. Up to 2000 braking operations can be executed with 300% rotor moment of inertia as external moment of inertia from a speed of 3000 RPM without the brake being subject to an inadmissible amount of wear. The specific highest switching work for each emergency braking operation may not be exceeded.
- The rated voltage of the holding brake is 24 V DC.



Caution

The rated voltage is 24 V DC +/- 10%. Voltages outside this tolerance bandwidth can result in faults.

Inadmissible wear means that the braking function can no longer be guaranteed! It is not permissible to exceed the above specified Emergency Stop conditions or to repeatedly briefly accelerate the motor against a holding brake that is still closed. This means that the switching times of the brakes and relays must be taken into account in the drive control and enable functions.

Brake types

Brakes with different principles of operation are used.

- Permanent-magnet brake
- Spring-operated brake

Both of the brake types operate according to the closed-circuit principle.

Mode of operation of a permanent-magnet brake

The magnetic field of the permanent magnets results in a pulling force on the brake armature disk. This means that in the no-current condition, the brake is closed and the motor shaft is held.

When 24 V DC rated voltage is connected to the brake, the solenoid - through which current flows - establishes an opposing field. This neutralizes the force of the permanent magnets. Permanent magnet brakes have a proportionally stiff connection to the motor rotor. This is the reason that this brake is almost without any play.

Caution

Motors with integrated permanent-magnet holding brake cannot be subject to axial forces at the shaft end! This applies when installing the system and during operation.

Mode of operation of a spring-operated brake

For a spring-operated brake, instead of the magnetic field of a permanent magnet, the force of a spring is used.

In order for a spring-operated brake to operate, the brake armature disk must be able to axially move. Therefore, rotational play cannot be avoided. When the brake is closed, the motor shaft can move by up to 1°.

Effect for hanging (suspended axes):

The motor brakes a hanging (suspended) axis electrically. If the brake is applied and the power is then disconnected, it is possible that the load could continue to move the motor shaft. In this case, the maximum possible motion corresponds to the above mentioned play in the gear meshing. The motion is appropriately stepped-up or stepped-down using a mounted gearbox.



Danger

Applications involving holding brakes for hanging/suspended axes must be especially carefully investigated as these represent a high potential hazard.

For motors with spring-operated brake, it must be carefully checked that the brake is suitable due to the rotational play.

For motors with spring-operated brakes, axial forces are permissible the same as for versions without brake.

Protective circuitry for the brake

Caution

In order to avoid overvoltages when shutting down and the possible negative impact on the plant or system environment, a protective circuit must be integrated into the brake feeder cable (refer to Fig. "Recommended circuit for the external power supply with protective circuit").

If protective circuitry is not used, voltage peaks up to 1000 V can occur in the millisecond range. Brake solenoid, switching contacts and electronic components could be destroyed.

Sensitive electronic components (e.g. logic components) can even be damaged as a result of a lower switch-off voltage. The power limits (e.g. ratings) of the components used should be carefully observed.

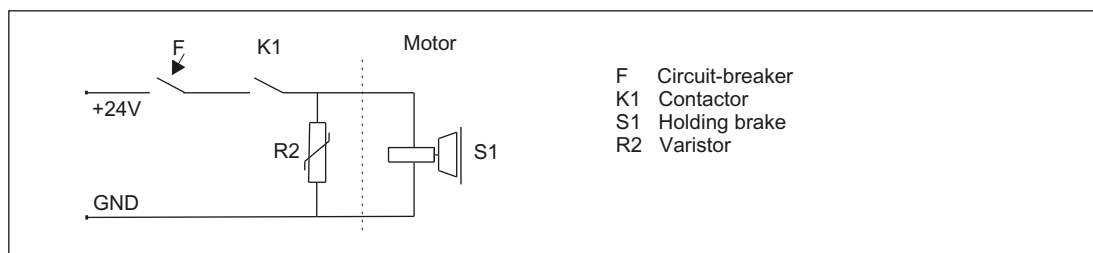

Figure 5-4 Recommended circuit for the external power supply with protective circuit

Table 5-2 Example: Electronic components for the recommended circuit

Electr. component	Examples		
F	3RV10 circuit-breaker with current paths connected in series. (if required with mounted auxiliary contact 3RV1901 to provide a feedback signal for the drive)	or	Miniature circuit-breaker 5SX21. (if required with mounted auxiliary contact to provide a feedback signal for the drive)
K1	Auxiliary contactor 3RH11	or	Contactor 3RT10
R2	Varistor SIOVS14K30 (EPCOS)		

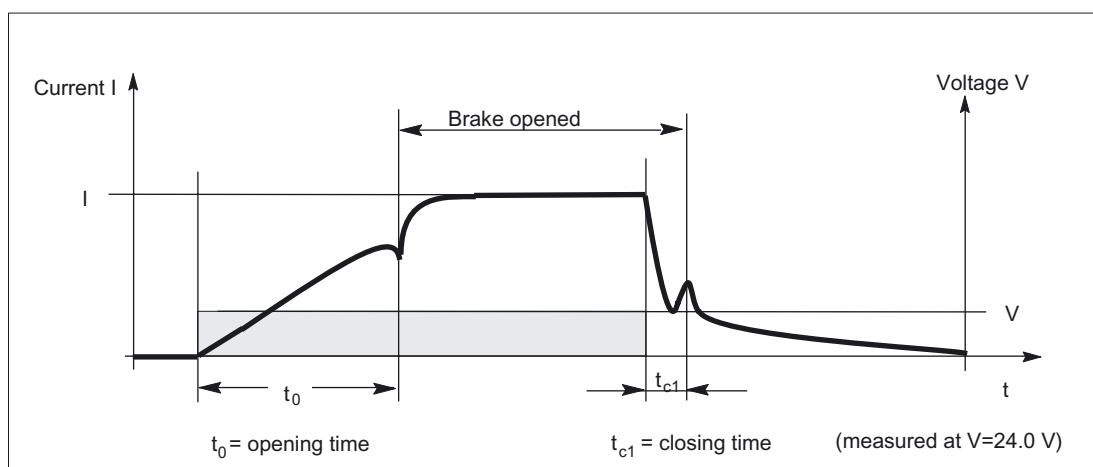

Figure 5-5 Terminology (time) for holding operation

Important information and instructions when installing the connecting cable

The brake connecting cable is included in the power cable. The insulation between the power and brake connection is dimensioned for the basic insulation (VDE 600 V/1000V UL). The relay K1, located between the coil and contact, must also have basic insulation in order to protect the internal logic voltage (PELV=Protective Extra Low Voltage). The PELV supply may not be used to supply the holding brake (refer to the Fig. "Recommended circuit for the external power supply with protective circuit").

Determining the minimum voltage

The minimum voltage of 24 V DC -10% must be available at the connector on the motor side in order to guarantee that the brake reliably opens. If the maximum voltage of 24 V DC +10 % is exceeded, then the brake could re-close. The voltage drop along the brake feeder cable must be taken into consideration.

The voltage drop for copper cables can be approximately calculated as follows:

$$dU = 0.042 \cdot (l/q) \cdot I_{\text{brake}}$$

l = cable length in m

q = brake conductor cross-section in mm²

I_{brake} = DC current of the brake in A

dV = voltage drop along the brake cable in V

Example: Calculating the voltage drop for 1FT6084 with EBD 3.5BN brake

$$I_{\text{brake}} = 0.9 \text{ A}, l = 50 \text{ m}, q = 1 \text{ mm}^2$$

$$dV = 0.042 \cdot 50/1 \cdot 0.9 = 1.89$$

This means that the voltage, on the supply side, must be a minimum of

$$24 \text{ V} \cdot 0.9 + 1.89 \text{ V} = 23.5 \text{ V}.$$

5.5 Thermal motor protection

A temperature-dependent resistor is integrated as temperature sensor to monitor the motor temperature.

Table 5-3 Features and technical data

Type	KTY 84 (PTC thermistor)
Resistance when cold (20°C)	approx. 580 Ohm
Resistance when hot (100°C)	approx. 1000 Ohm
Connecting	via signal cable

The resistance of the KTY 84 thermistor changes proportionally to the winding temperature change.

The temperature signal is sensed and evaluated in the drive converter whose closed-loop control takes into account the temperature characteristic of the motor resistances.

When a fault occurs, an appropriate message is output at the drive converter. When the motor temperature increases, a message "Alarm motor overtemperature" is output; this must be externally evaluated. If this signal is not observed, the drive converter shuts down with the appropriate fault message when the motor limiting temperature or the shutdown temperature is exceeded.



Warning

If the user carries-out an additional high-voltage test, then the ends of the temperature sensor cables must be short-circuited before the test is carried-out!

If the test voltage is connected to a temperature sensor terminal, then it will be destroyed.

The polarity must be carefully observed.

The temperature sensor is designed so that the DIN/EN requirement for "protective separation" is fulfilled.



Caution

The integrated temperature sensor protects the synchronous against an overload condition

Shaft heights, 28 to 48 up to $2 \cdot I_{0.60K}$ and speed $\neq 0$

from shaft height 63 up to $4 \cdot I_{0.60K}$ and speed $\neq 0$

For load applications that are critical from a thermal perspective - e.g. overload when the motor is stationary or an overload of M_{max} longer than 4 s, adequate protection is no longer available.

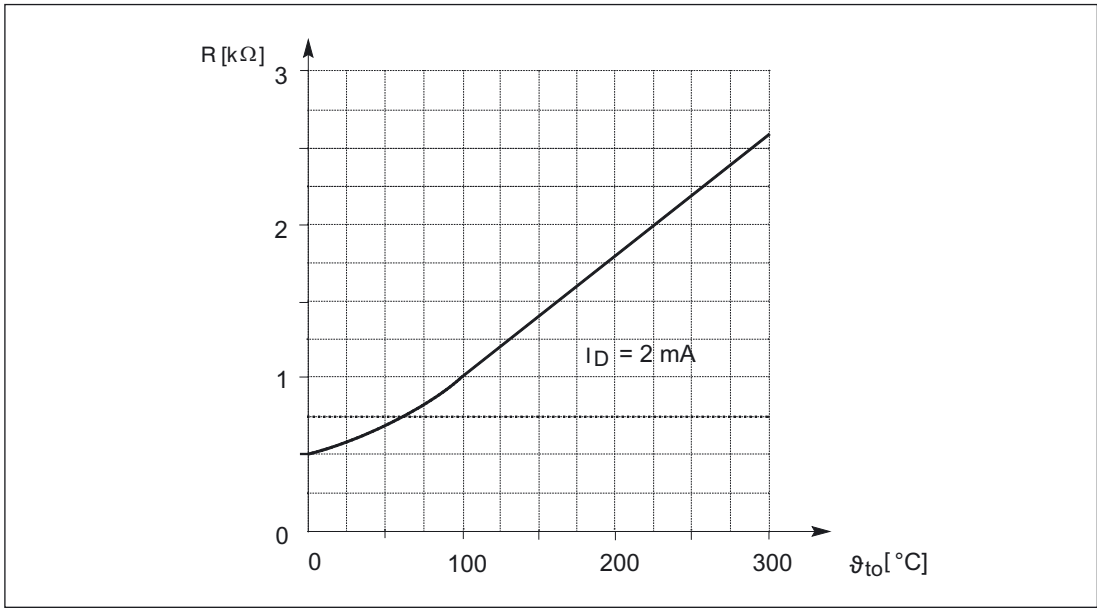

Figure 5-6 Resistance characteristic of the KTY 84 as a function of the temperature

Appendix

A.1 References

An overview of publications that is updated monthly is provided in a number of languages in the Internet at:

<<http://www.siemens.com/motioncontrol>>
through "Support", "Technical Documentation", "Documentation Overview"

General Documentation

/D 21.2/	SINAMICS S120 Catalog SINAMICS S120 Servo Control Drive System
/D 21.1/	SINAMICS S120 Catalog SINAMICS S120 Vector Control Drive System
/NC 60/	SINUMERIK and SIMODRIVE Catalog Automation Systems for Machine Tools
/NC 61/	SINUMERIK and SINAMICS Catalog Automation Systems for Machine Tools
/DA65.3/	SIMOVERT MASTERDRIVES Catalog Synchronous and Induction Motors for SIMOVERT MASTERDRIVES

Electronic Documentation

- /CD1/** **DOC ON CD**
The SINUMERIK System
(includes all SINUMERIK 840D/810D and SIMODRIVE 611D)
- /CD2/** **DOC ON CD**
The SINAMICS System

Manufacturer/Service Documentation

- /PJAL/** **Configuration Manual, Synchronous Motors**
SIMODRIVE 611, SIMOVERT MASTERDRIVES MC
Synchronous Motors General Section
- /PFK7S/** **Configuration Manual, Synchronous Motors**
SINAMICS S120
1FK7 Synchronous Motors
- /PFT6S/** **Configuration Manual, Synchronous Motors**
SINAMICS S120
1FT6 Synchronous Motors
- /PMH2/** **Configuration Manual, Hollow-Shaft Measuring System**
SINAMICS S120, SIMODRIVE 611, SIMOVERT MASTERDRIVES,
SIMAG H2 Hollow-Shaft Measuring System
- /PFK7/** **Configuration Manual, Synchronous Motors**
SIMODRIVE 611, SIMOVERT MASTERDRIVES
1FK7 Synchronous Motors
- /PFT6/** **Configuration Manual, Synchronous Motors**
SIMODRIVE 611, SIMOVERT MASTERDRIVES
1FT6 Synchronous Motors

/PFK6/	Configuration Manual, Synchronous Motors SIMODRIVE 611, SIMOVERT MASTERDRIVES 1FK6 Synchronous Motors
/PFS6/	Configuration Manual, Synchronous Motors SIMOVERT MASTERDRIVES 1FS6 Synchronous Motors, Explosion-Protected
/PFU/	Configuration Manual, Synchronous Motors SINAMICS S120, SIMOVERT MASTERDRIVES, MICROMASTER SIEMOSYN Synchronous Motors 1FU8
/ASAL/	Configuration Manual, Induction Motors SIMODRIVE 611, SIMOVERT MASTERDRIVES Induction Motors General Section
/APH2/	Configuration Manual, Induction Motors SIMODRIVE 611 1PH2 Induction Motors
/APH4/	Configuration Manual, Induction Motors SIMODRIVE 611 1PH4 Induction Motors
/APH7/	Configuration Manual, Induction Motors SIMODRIVE 611 1PH7 Induction Motors
/PPM/	Configuration Manual, Hollow-Shaft Motors SIMODRIVE 611 Hollow Shaft Motors for Main Spindle Drives 1PM6 and 1PM4

/PJFE/	Configuration Manual, Synchronous Built-in Motors SIMODRIVE 611 Synchronous Motors for Main Spindle Drives 1FE1 Synchronous Built-in Motors
/PJTM/	Configuration Manual, Built-in Torque Motors SIMODRIVE 611 Built-in Torque Motors 1FW6
/PJLM/	Configuration Manual, Linear Motors SIMODRIVE 611 Linear Motors 1FN1 and 1FN3
/PMS/	Configuration Manual, ECO Motor Spindle SIMODRIVE 611 ECO Motor Spindle 2SP1
/APL6/	Configuration Manual, Induction Motors SIMOVERT MASTERDRIVES Induction Motors 1PL6
/APH7M/	Configuration Manual, Induction Motors SIMOVERT MASTERDRIVES VC/MC Induction Motors 1PH7
/PKTM/	Configuration Manual, Complete Torque Motors SIMOVERT MASTERDRIVES Complete Torque Motors 1FW3

Index

A

Armature short-circuit braking, 5-4
Axial eccentricity, 2-3

B

Balancing, 2-4
Bearings, 2-2
Brake resistor, 1-10, 5-4
Braking torque, 1-11

C

Calculation
 Motor rms torque, 3-10
 Motor speed, 3-10
 Motor torque in a time slice, 3-10
Concentricity, 2-3
Configuration, 3-2
Cooling, 2-7

D

Degree of protection, 2-4
Drive-out couplings, 5-2

E

Effects on mounting, 5-1
Electrical time constant, 1-10
Engineering software, 3-2
ESDS instructions, vii

H

Holding brake, 5-7
Hotline, iv

I

Inductance, 1-10

L

Limiting voltage characteristic, 1-4

M

M/I characteristic, 1-9
Maximum current, 1-7
Maximum rotational speed, 1-8
Maximum torque, 1-8
Mechanical time constant, 1-10
Mechanical turning, 2-2
Moment of inertia, 1-10
Motor rms torque, 3-10
Motor selection, 3-2
Motor torque, 3-10

N

NCSD Configurator, 3-1
Noise, 2-3

O

Operation under vibrational conditions, shock
 stressing, 2-4
Optimum power, 1-8
Optimum speed, 1-8

P

Paint, 2-4
PATH Plus, 3-2
Power cable, 4-1, 4-3
Power cable cross-sections, 4-1
Procedure when engineering, 3-4

R

Radial eccentricity tolerance, 2-3
Rated current, 1-7
Rated speed, 1-7
Rated torque, 1-7
Resistance characteristic, 5-12

S

Safety Guidelines, v
Shaft end, 2-2
Shaft torsional stiffness, 1-10
Signal lines, 4-7
Stall current, 1-7
Standard engineering, 3-2
Static torque, 1-7
Surface temperature, 2-2

T

Technical Support, iv
Temperature sensor, KTY 84, 5-11
Thermal limiting characteristic, 1-3
Thermal motor protection, 5-11
Thermal time constant, 1-10
Tolerance data, 1-11
Torque characteristics, 1-2
Torque constant, 1-9

V

Vibration severity, 2-3
Voltage constant, 1-10

W

Winding resistance, 1-10

To
 SIEMENS AG
 A&D MC BMS
 Postfach 3180
 D-91050 Erlangen
 Tel.: +49 (0) 180 / 5050 - 222 (Service Support)
 Fax: +49 (0) 9131 / 98 - 63315 (Documentation)
 mailto:motioncontrol.docu@siemens.com

Suggestions	
Corrections	
For Publication/Manual:	
Synchronous Motors General Section	
Manufacturer/Service Documentation	
Configuration Manual	
Order No.:	6SN1197-0AD07-0BP4
Edition:	11.2005
If you come across any printing errors in this document, please let us know using this form. We would also be grateful for any suggestions and recommendations for improvement.	

From	
Name	
Company/Department	
Address	
Postal code:	Town:
Telephone:	/
Telefax:	/

Suggestions and/or corrections

